

Digital Still Camera

Instruction Manual



“Help Guide” (Web manual)

Refer to “Help Guide” for in-depth instructions on the many functions of the camera.

http://rd1.sony.net/help/dsc/1550/h_zz/

Cyber-shot

English

Learning more about the camera (“Help Guide”)



“Help Guide” is an on-line manual. You can read the “Help Guide” on your computer or smartphone. Refer to it for in-depth instructions on the many functions of the camera.

URL:

http://rd1.sony.net/help/dsc/1550/h_zz/



Owner's Record

The model and serial numbers are located on the bottom. Record the serial number in the space provided below. Refer to these numbers whenever you call your Sony dealer regarding this product.

Model No. WW843944 (DSC-RX1RM2)

Serial No. _____

Model No. AC- _____

Serial No. _____

WARNING

To reduce fire or shock hazard, do not expose the unit to rain or moisture.

IMPORTANT SAFETY INSTRUCTIONS -SAVE THESE INSTRUCTIONS DANGER TO REDUCE THE RISK OF FIRE OR ELECTRIC SHOCK, CAREFULLY FOLLOW THESE INSTRUCTIONS

If the shape of the plug does not fit the power outlet, use an attachment plug adaptor of the proper configuration for the power outlet.



CAUTION

Battery pack

If the battery pack is mishandled, the battery pack can burst, cause a fire or even chemical burns. Observe the following cautions.

- Do not disassemble.
- Do not crush and do not expose the battery pack to any shock or force such as hammering, dropping or stepping on it.
- Do not short circuit and do not allow metal objects to come into contact with the battery terminals.
- Do not expose to high temperature above 60°C (140°F) such as in direct sunlight or in a car parked in the sun.
- Do not incinerate or dispose of in fire.
- Do not handle damaged or leaking lithium ion batteries.
- Be sure to charge the battery pack using a genuine Sony battery charger or a device that can charge the battery pack.
- Keep the battery pack out of the reach of small children.
- Keep the battery pack dry.
- Replace only with the same or equivalent type recommended by Sony.
- Dispose of used battery packs promptly as described in the instructions.

AC Adaptor

Use the nearby wall outlet (wall socket) when using the AC Adaptor. Disconnect the AC Adaptor from the wall outlet (wall socket) immediately if any malfunction occurs while using the apparatus.

For Customers in the U.S.A. and Canada

RECYCLING LITHIUM-ION BATTERIES

Lithium-Ion batteries are recyclable.

You can help preserve our environment by returning your used rechargeable batteries to the collection and recycling location nearest you.



For more information regarding recycling of rechargeable batteries, call toll free 1-800-822-8837, or visit <http://www.call2recycle.org/>

Caution: Do not handle damaged or leaking Lithium-Ion batteries.

For supplied accessories

This device complies with Part 15 of the FCC Rules. Operation is subject to the following two conditions:

(1) This device may not cause harmful interference, and (2) this device must accept any interference received, including interference that may cause undesired operation.

CAN ICES-3 B/NMB-3 B

This equipment complies with FCC/IC radiation exposure limits set forth for an uncontrolled environment and meets the FCC radio frequency (RF) Exposure Guidelines and RSS-102 of the IC radio frequency (RF) Exposure rules. This equipment has very low levels of RF energy that are deemed to comply without testing of specific absorption ratio (SAR).

For Customers in the U.S.A.

If you have any questions about this product, you may call:

Sony Customer Information Center
1-800-222-SONY (7669).

The number below is for the FCC related matters only.

Regulatory Information

Declaration of Conformity

Trade Name: SONY
Model No.: WW843944
Responsible Party: Sony Electronics Inc.
Address: 16535 Via Esprillo,
San Diego, CA 92127 U.S.A.
Telephone No.: 858-942-2230

This device complies with Part 15 of the FCC Rules. Operation is subject to the following two conditions: (1) This device may not cause harmful interference, and (2) this device must accept any interference received, including interference that may cause undesired operation.

This equipment must not be co-located or operated in conjunction with any other antenna or transmitter.

CAUTION

You are cautioned that any changes or modifications not expressly approved in this manual could void your authority to operate this equipment.

Note:

This equipment has been tested and found to comply with the limits for a Class B digital device, pursuant to Part 15 of the FCC Rules.

These limits are designed to provide reasonable protection against harmful interference in a residential installation. This equipment generates, uses, and can radiate radio frequency energy and, if not installed and used in accordance with the instructions, may cause harmful interference to radio communications. However, there is no guarantee that interference will not occur in a particular installation. If this equipment does cause harmful interference to radio or television reception, which can be determined by turning the equipment off and on, the user is encouraged to try to correct the interference by one or more of the following measures:

- Reorient or relocate the receiving antenna.
- Increase the separation between the equipment and receiver.
- Connect the equipment into an outlet on a circuit different from that to which the receiver is connected.
- Consult the dealer or an experienced radio/TV technician for help.

The supplied interface cable must be used with the equipment in order to comply with the limits for a digital device pursuant to Subpart B of Part 15 of FCC Rules.

For Customers in Canada

This device complies with Industry Canada's licence-exempt RSSs. Operation is subject to the following two conditions:

- (1) This device may not cause interference; and
- (2) This device must accept any interference, including interference that may cause undesired operation of the device.

For Customers in Europe

Notice for the customers in the countries applying EU Directives

Manufacturer: Sony Corporation, 1-7-1 Konan Minato-ku Tokyo, 108-0075 Japan
For EU product compliance: Sony Deutschland GmbH, Hedelfinger Strasse 61, 70327 Stuttgart, Germany



Hereby, Sony Corporation, declares that this equipment is in compliance with the essential requirements and other relevant provisions of Directive 1999/5/EC. For details, please access the following URL: <http://www.compliance.sony.de/>

Notice

If static electricity or electromagnetism causes data transfer to discontinue midway (fail), restart the application or disconnect and connect the communication cable (USB, etc.) again.

This product has been tested and found compliant with the limits set out in the EMC regulation for using connection cables shorter than 3 meters (9.8 feet).

The electromagnetic fields at the specific frequencies may influence the picture and sound of this unit.

Disposal of waste batteries and electrical and electronic equipment (applicable in the European Union and other European countries with separate collection systems)



This symbol on the product, the battery or on the packaging indicates that the product and the battery shall not be treated as household waste. On

certain batteries this symbol might be used in combination with a chemical symbol. The chemical symbols for mercury (Hg) or lead (Pb) are added if the battery contains more than 0.0005% mercury or 0.004% lead. By ensuring these products and batteries are disposed of correctly, you will help prevent potentially negative consequences for the environment and human health which could otherwise be caused by inappropriate waste handling. The recycling of the materials will help to conserve natural resources.

In case of products that for safety, performance or data integrity reasons require a permanent connection with an incorporated battery, this battery should be replaced by qualified service staff only. To ensure that the battery and the electrical and electronic equipment will be treated properly, hand over these products at end-of-life to the applicable collection point for the recycling of electrical and electronic equipment. For all other batteries, please view the section on how to remove the battery from the product safely. Hand the battery over to the applicable collection point for the recycling of waste batteries.

For more detailed information about recycling of this product or battery, please contact your local Civic Office, your household waste disposal service or the shop where you purchased the product or battery.

For Customers in Singapore

Complies with
IMDA Standards
DB00353

For customers who purchased their camera from a store in Japan that caters to tourists

Note

Some certification marks for standards supported by the camera can be confirmed on the screen of the camera.

Select MENU →  (Setup) → [Certification Logo].

If display is not possible due to problems such as camera failure, contact your Sony dealer or local authorized Sony service facility.

For Customers in U.A.E.

TRA
REGISTERED No:
ER0098751/12

DEALER No:
DA0073692/11

For Customers in Malaysia



Table of contents

Introduction of functions	10
---------------------------------	----

Before use

Notes on using your camera	12
Checking the supplied items	16
Identifying parts	17
Front side	17
Rear side	18
Top side/Side view	19
Bottom view	21
Using the viewfinder	22
Attaching the eyepiece cup (supplied)	23
List of icons on the monitor	25

Functions list

Functions that can be operated using the buttons/dials	29
How to use the Quick Navi screen	30
Operating the camera	32
How to use the control wheel	32
How to use the control dial	32
Selecting a function using the Fn (Function) button	33
Functions that can be registered using the Fn (Function) button	34
Functions that can be selected using the MENU button	35
Using the In-Camera Guide	46

Preparing the camera

Charging the battery pack	47
Charging time (Full charge)	50
Charging by connecting to a computer	51
Checking the remaining battery charge	51
Supplying power from a wall outlet (wall socket)	52
To remove the battery pack	53
Inserting a memory card (sold separately)	54
Formatting the memory card	55
Memory cards that can be used	55
Setting the language and the clock	57
Checking or resetting the date/time and area	58
Shooting a clear image without camera shake	59
Holding the camera properly	59
SteadyShot function for movie shooting	60

Shooting and viewing images

Shooting still images	61
Recording movies	63
Playing back images	64
Switching between still images and movies	65
Playback functions	65
Deleting images	66

Selecting a shooting mode

Selecting a shooting mode	67
Functions available for each shooting mode	68

Various functions

Using the various functions	69
 Image Size (still image)	69
Auto focus functions	70
Creative Style	71
DRO/Auto HDR	71
LPF Effect	72

Using Wi-Fi functions

Using the Wi-Fi and NFC one-touch functions	73
Connecting the camera to a wireless access point	74

Using applications

Adding applications to the camera (PlayMemories Camera Apps)	75
Downloading applications	75
Launching the application	76

Using a computer

Developing RAW images (Image Data Converter)	77
Installing Image Data Converter	77
Importing images to your computer and using them (PlayMemories Home)	78
Installing PlayMemories Home	79
Controlling the camera using your computer (Remote Camera Control)	80
Installing Remote Camera Control	80

Others

Checking the number of images and recordable time of movies	81
Specifications	85

Index	89
--------------------	-----------

For details on the Wi-Fi and NFC One-touch functions, refer to the attached document “Wi-Fi Connection/One-touch (NFC) Guide” or to the “Help Guide.”

About language setting

Change the screen language before using the camera if necessary (page 57).

Introduction of functions

This section introduces some frequently used shooting functions and other unique functions.

See the pages in parentheses for details.

Shooting functions used frequently

Exposure Comp. (37)

You can adjust the exposure to change the brightness of the entire image. Even when the shooting mode is set to M, you can adjust the exposure if the ISO sensitivity is set to [ISO AUTO].

ISO/Multi Frame NR (37)

You can adjust the luminous sensitivity.

The ISO sensitivity can be adjusted between ISO 50 and ISO 102400.

White Balance (37)

You can adjust the color tones.

You can select an option to suit a light source, or perform fine adjustments using color temperature and color filters.

Drive Mode (36)

You can select an appropriate drive mode to suit your purposes, such as single shooting, continuous shooting, or bracket shooting.

Focus Mode (70)/Focus Area (70)

You can adjust various settings for the focus.

You can select the focusing method or focusing area as desired to match your subject.

Focus Magnifier (38)/MF Assist (39)

Enlarge the image to make checking the focus easier when focusing manually.

Features of this camera

Shooting still images in 42 megapixels (69)

You can shoot still images with extremely high resolution.

Shooting with the viewfinder (22)

You can shoot images with the built-in pop-up viewfinder.

Low pass filter effect (72)

You can change the level of the low pass filter effect according to your subject.

Fast and accurate auto focus (70)

Enables faster and more accurate auto focus combining contrast AF and phase detection AF that detects 399 points.

Macro mode (62)

You can shoot close-ups of subjects such as flowers or food.

How to operate or customize the camera

Display information (40)

When you look into the raised viewfinder, viewfinder mode is activated, and when you move your face away from the viewfinder, the viewing mode reverts to monitor mode (default settings). You can change the screen display mode by pressing DISP on the control wheel.

Quick Navi (30)

In [For viewfinder] screen, you can quickly switch from the monitor to the Quick Navi screen by pressing the Fn button. You can set the items with an intuitive operation by using the control dial and the control wheel.

Customization (41)

The camera are equipped with the Custom buttons, where you can assign desired function on each button. You can also assign functions to other buttons, such as the AEL button.

Notes on using your camera

Screen language

You can select the language displayed on the screen using the menu (page 44).

Shooting procedure

This camera has 2 modes for monitoring subjects: the monitor mode using the monitor, and the viewfinder mode using the viewfinder.

Functions built into this camera

This camera is compatible with 1080 60p or 50p-format movies. Unlike standard recording modes up to now, which record in an interlacing method, this camera records using a progressive method. This increases the resolution, and provides a smoother, more realistic image.

Creating an image database file

If you insert a memory card that does not contain an image database file into the camera and turn on the power, the camera automatically creates an image database file using some of the memory card's capacity.

The process may take a long time and you cannot operate the camera until the process is completed. If a database file error occurs, export all images to your computer using PlayMemories Home™, and then format the memory card using the camera.

Notes on recording/playback

- In order to stabilize the operation of the memory card, it is recommended that you format the memory card on the camera when you use it with that camera for the first time.
Once you format the memory card, all the data recorded on the memory card will be deleted and cannot be restored. Before formatting, copy the data to a computer or other device.
- If you repeatedly record and delete images over a long period, the files on the memory card may become fragmented and movie recording may be suspended partway through. If this occurs, copy the data to a computer or other device and then perform [Format].
- Before you start recording, make a trial recording to make sure that the camera is working correctly.
- The camera is neither dust-proof, nor splash-proof, nor water-proof.

Back up recommendation for a memory card

If you turn the camera off, remove the battery pack or the memory card, or disconnect the USB cable while the access lamp is flashing, the data on the memory card may become damaged. To avoid data loss, always copy (back up) data to another device.

No compensation for damaged content or recording failure

Sony can provide no guarantees in the event of failure to record or loss or damage of recorded images or audio data due to a malfunction of the camera or recording media, etc. We recommend backing up important data.

ZEISS lens

The camera is equipped with a ZEISS lens which is capable of reproducing sharp images with excellent contrast. The lens for the camera has been produced under a quality assurance system certified by ZEISS in accordance with the quality standards of ZEISS in Germany.

Notes on the monitor, electronic viewfinder, lens, and image sensor

- The monitor and electronic viewfinder are manufactured using extremely high-precision technology, and over 99.99% of the pixels are operational for effective use. However, there may be some small black dots and/or bright dots (white, red, blue or green in color) that constantly appear on the monitor and electronic viewfinder. These dots are normal due to the manufacturing process and do not affect the images in any way.
- Do not hold the camera by the monitor or the viewfinder.
- Take care that your finger is not in the way when pushing the viewfinder down.
- If water, dust or sand adheres to the viewfinder unit, it may cause a malfunction.
- Do not expose the camera to sunlight or shoot sunward for a long time. The internal mechanism may be damaged.
- Do not use the camera in areas where strong radio waves or radiation are being emitted. Recording and playback may not function correctly.

- Magnets are attached to the camera body and the back of the monitor. Do not put objects that are affected by magnetic fields, such as floppy disks or credit cards, between the monitor and the camera body.

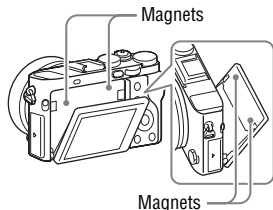

- Images may trail across on the screen in a cold location. This is not a malfunction. When turning on the camera in a cold location, the screen may become temporarily dark. When the camera warms up, the screen will function normally.
- The recorded image may be different from the image you monitored before recording.

Notes on using accessories

It is recommended that you use Sony accessories designed to suit the characteristics of this camera. Using this camera with products from other manufacturers may affect its performance, leading to accidents or malfunction. Sony bears no responsibility for such accidents or malfunction.

Notes on the multi interface shoe

- When attaching or detaching accessories such as an external flash to the multi interface shoe, first turn the power to OFF. When attaching the accessories, tighten the screws all the way and confirm that it is firmly fastened to the camera.

- Do not use an external flash with a high voltage flash sync terminal or inverse polarity. This may result in malfunction.

Notes on shooting with the viewfinder

This camera is equipped with an Organic Electro-Luminescence viewfinder with high resolution and high contrast. This viewfinder achieves a wide viewing angle and a long eye relief. This camera is designed to provide an easily viewable viewfinder by appropriately balancing various elements.

- The image may be slightly distorted near the corners of the viewfinder. This is not a malfunction. When you want to see the full composition with all its details, you can also use the monitor.
- If you pan the camera while looking into the viewfinder or move your eyes around, the image in the viewfinder may be distorted or the color of the image may change. This is a characteristic of the lens or display device and is not a malfunction. When you shoot an image, we recommend that you look at the center area of the viewfinder.
- When shooting with the viewfinder, you may experience symptoms such as eyestrain, fatigue, travel sickness, or nausea. We recommend that you take a break at regular intervals when you are shooting with the viewfinder. The required length or frequency of the break may differ depending on the individuals, so you are advised to decide at your own discretion. In case you may feel uncomfortable, refrain from using the viewfinder until your condition recovers, and consult your doctor as necessary.

Notes on recording for long periods of time

- Depending on the camera and battery temperature, you may be unable to record movies or the power may turn off automatically to protect the camera. A message will be displayed on the screen before the power turns off or you can no longer record movies. In this case, leave the power off and wait until the camera and battery temperature goes down. If you turn on the power without letting the camera and battery cool enough, the power may turn off again or you may be unable to record movies.
- Under high ambient temperatures, the temperature of the camera rises quickly.
- When the temperature of the camera rises, the image quality may deteriorate. It is recommended that you wait until the temperature of the camera drops before continuing to shoot.
- The surface of the camera may get warm. This is not a malfunction.

Notes on importing XAVC S movies and AVCHD movies to a computer

When importing XAVC S movies or AVCHD movies to a computer, download and use the software PlayMemories Home from the following website:
<http://www.sony.net/pm/>

Notes when playing movies on other devices

- Movies recorded with this camera may not be played back correctly on other devices. Also, movies recorded with other devices may not be played back correctly on this camera.

- Discs created from AVCHD movies recorded by this camera can be played back only on AVCHD-compatible devices. DVD players or recorders cannot play back discs created from AVCHD movies, as they are incompatible with the AVCHD format. Also, DVD players or recorders may fail to eject HD discs recorded in AVCHD format.
- Movies recorded in 1080 60p/1080 50p format can be played back only on 1080 60p/1080 50p-supported devices.
- Movies recorded in XAVC S format can be played back only on XAVC S-supported devices.

Warning on copyright

- Television programs, films, videotapes, and other materials may be copyrighted. Unauthorized recording of such materials may be contrary to the provisions of the copyright laws.
- To prevent [Copyright Info] from being used illegally, leave [Set Photographer] and [Set Copyright] blank when you lend or transfer the camera.
- Sony bears no responsibility for any trouble or damage caused by unauthorized use of [Copyright Info].

The pictures used in this manual

The photographs used as examples of pictures in this manual are reproduced images, and are not actual images shot using this camera.

On the data specifications described in this manual

The data on performance and specifications are defined under the following conditions, except as described in this manual: at an ordinary ambient temperature of 25°C (77°F), and using a battery pack that has been fully charged until the charge lamp has turned off.

How to turn off wireless network functions (Wi-Fi and NFC, etc.) temporarily

When you board an airplane, etc., you can turn off all wireless network functions temporarily.

Select MENU button →  (Wireless) → [Airplane Mode] → [On].

If you set [Airplane Mode] to [On], an  (airplane) mark will be displayed on the screen.

Notes on wireless LAN

If your camera is lost or stolen, Sony bears no responsibility for the loss or damage caused by illegal access or use of the registered access point on the camera.

Notes on security when using wireless LAN products

- Always make sure that you are using a secure wireless LAN to avoid hacking, access by malicious third parties, or other vulnerabilities.
- It is important that you set the security settings when using a wireless LAN.
- If a security problem arises because no security precautions are in place or due to any inevitable circumstances when using a wireless LAN, Sony bears no responsibility for the loss or damage.

Checking the supplied items

The number in parentheses indicates the number of pieces.

- Camera (1)
- AC Adaptor (1)

The shape of the AC Adaptor may differ depending on the country/region.

- Battery charger (1)
- Power cord (mains lead) (1)
(supplied in some countries/
regions)



- Rechargeable battery pack NP-BX1 (1)

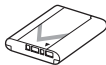

- Micro USB cable (1)

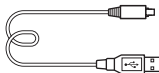

- Shoulder strap (1)



For how to attach the shoulder strap to the camera, refer to page 19.

- Lens cap (1)



- Shoe cap (1) (Attached on the camera)
- Eyepiece cup (1)



For how to attach the eyepiece cup to the camera, refer to page 23.

- Cleaning cloth (1)
- Instruction Manual (1) (this manual)
- Wi-Fi Connection/One-touch (NFC) Guide (1)

This guide explains the functions that require a Wi-Fi connection.

Identifying parts

See the pages in parentheses for details on operation for the parts.

Front side

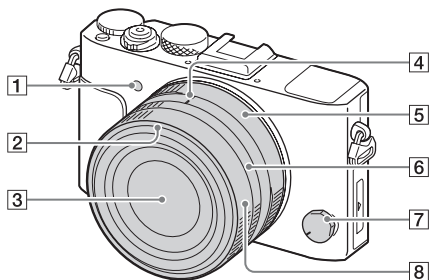

- | | |
|---|------------------------------------|
| 1 AF illuminator (37)/Self-timer lamp | 5 Aperture ring (29) |
| 2 Lens hood index | 6 Macro switching ring (62) |
| 3 Lens | 7 Focus mode dial (70) |
| 4 Aperture index/Macro switching index | 8 Focusing ring |

Rear side

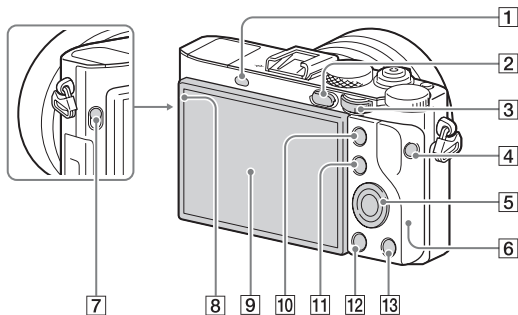

- 1** Eye sensor
- 2** (Playback) button (64)
- 3** Control dial (32)
- 4** MOVIE button (63)
- 5** Control wheel (32)
- 6** Wi-Fi antenna (built-in)
- 7** FINDER (Viewfinder pop-up) switch (22)
- 8** Light sensor
- 9** Monitor (25)
 - You can adjust the monitor to an easily viewable angle and shoot from any position.
- 10** For shooting: AEL button (29)
For viewing: (Enlarge) button (65)
- 11** For shooting: Fn button (33)
For viewing: (Image index) button (65)
- 12** MENU button (35)
- 13** For shooting: C2 (Custom 2) button (29)
For viewing: (Delete) button (66)

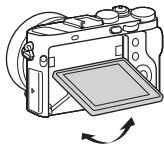

Top side/Side view

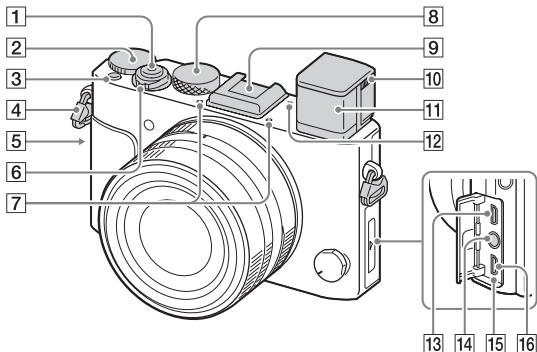

- 1** Shutter button (61)
- 2** Exposure compensation dial (29)
- 3** C1 (Custom 1) button (29)
- 4** Hooks for shoulder strap
- Attach both ends of the strap onto the camera.

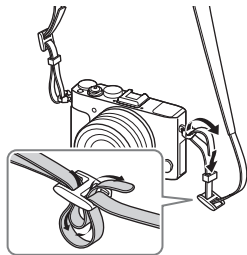

- 5** **N** (N mark)

- This mark indicates the touch point for connecting the camera and an NFC-enabled Smartphone.

For details on the location of the **N** (N mark) on your Smartphone, refer to the operating instructions of the Smartphone.

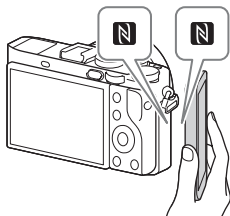

- NFC (Near Field Communication) is an international standard of short-range wireless communication technology.
- 6** ON/OFF (Power) switch (57)
- 7** Built-in microphone*¹
- 8** Mode dial (67)
- 9** Multi interface shoe*²
- When the viewfinder is popped up, some accessories may not be attached. In that case, use the camera with the viewfinder pushed down.
 - Some of the accessories may not be inserted fully and protrude backward from the Multi interface shoe. However, when the accessory reaches the front end of the shoe, the connection is completed.
- 10** Diopter-adjustment slider (22)
- Adjust the diopter-adjustment slider according to your eyesight until the display appears clearly in the viewfinder.
- 11** Viewfinder (22)
- 12** ⊖ Image sensor position mark
- 13** HDMI micro jack
- 14**  (Microphone) jack*³
- When an external microphone is connected, the microphone is turned on automatically. If the external microphone is a plug-in-power type, the power of the microphone is supplied by the camera.
- 15** Charge lamp (49)
- 16** Multi/Micro USB Terminal*²
- Supports Micro USB compatible device.
- *¹ Do not cover this part while recording movies. Doing so may cause noise or lower the volume.
- *² For details on compatible accessories for the multi interface shoe and the Multi/Micro USB Terminal, visit the Sony website, or consult your Sony dealer or local authorized Sony service facility. You can also use accessories that are compatible with the accessory shoe. Operations with other manufactures' accessories are not guaranteed.

ni Multi
Interface Shoe

Accessory Shoe

- *³ When an external microphone is connected, you cannot connect cables to the HDMI micro jack and the Multi/Micro USB Terminal.

Bottom view

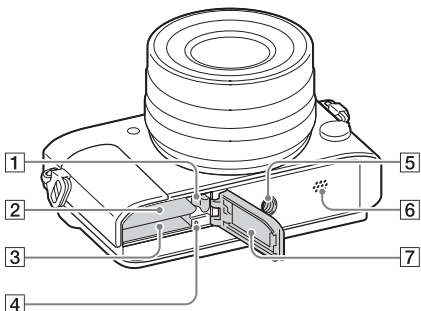

Before use

- 1 Battery lock lever
- 2 Battery insertion slot (48)
- 3 Memory card slot (54)
- 4 Access lamp
- 5 Tripod socket hole
 - Use a tripod with a screw less than 5.5 mm (7/32 inches) long. Otherwise, you cannot firmly secure the camera, and damage to the camera may occur.
- 6 Speaker
- 7 Battery/Memory card cover (48, 54)

Using the viewfinder

- 1 Slide down the FINDER (viewfinder pop-up) switch to raise the viewfinder.**

FINDER (viewfinder pop-up) switch

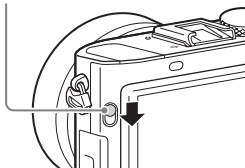

- 2 Adjust the diopter-adjustment slider until the display appears clearly in the viewfinder.**

Diopter-adjustment slider

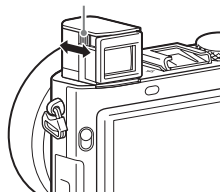

To store the viewfinder

Push down the top of the viewfinder.

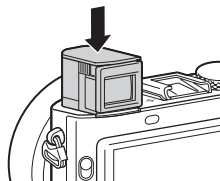





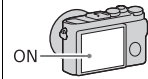
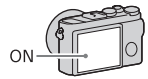
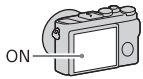
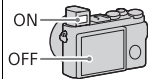
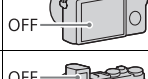
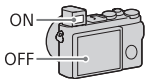
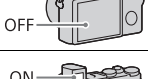
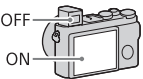
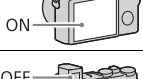
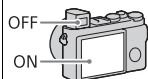

Notes

- Be careful not to push down on the viewfinder when it is being raised.
- When storing the viewfinder, push it down slowly to keep the eyepiece from getting stuck in the process.
- Do not carry the camera by the viewfinder.

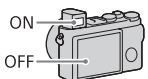
Switching between the viewfinder and the monitor

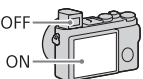
The displays on the viewfinder and monitor may differ depending on the viewfinder status and the [FINDER/MONITOR] setting (page 40).

[FINDER/MONITOR] setting	Auto	Viewfinder (Manual)	Monitor (Manual)
When the viewfinder is closed			
When you look into the viewfinder	 	 	 
When you are not looking into the viewfinder	 	 	 

Before use

Using an external electronic viewfinder (sold separately)

This camera is compatible with the FDA-EV1MK external electronic viewfinder (sold separately). When an external electronic viewfinder is attached to the camera, the built-in viewfinder cannot be used.

Notes

- When you are using an external electronic viewfinder, you can change the settings for [Viewfinder Bright.] (page 43) but not for [Finder Color Temp.] (page 43).

Attaching the eyepiece cup (supplied)

The eyepiece cup shades the area between the viewfinder and your eye to keep out light. Attaching the eyepiece cup improves the visibility of the viewfinder.

- 1 Slide down the **FINDER (viewfinder pop-up) switch** to raise the viewfinder (page 22).

2 Make sure that the end of the eyepiece cup screw is not sticking out of the frame.

- If the screw is sticking out of the frame, loosen the screw.

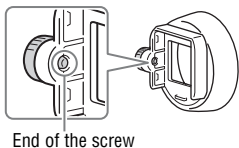

3 While holding the eyepiece between your fingers, insert the eyepiece cup into the eyepiece.

- Insert the eyepiece cup until it pops in.

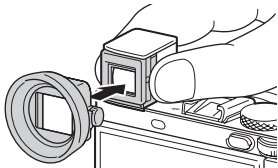

4 Tighten the screw to lock the eyepiece cup in place.

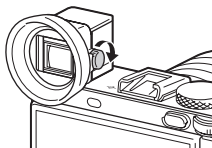

To remove the eyepiece cup

Loosen the eyepiece cup screw and remove the eyepiece cup.

Notes

- When the eyepiece cup is attached, the viewfinder cannot be stored.
- Do not push down the viewfinder with the eyepiece cup attached. The camera or the eyepiece cup may be damaged.
- If it is hard to operate the diopter-adjustment slider (page 22) because the eyepiece cup is attached, remove the eyepiece cup before operating the diopter-adjustment slider.
- When the eyepiece cup is attached, some accessories cannot be attached.

List of icons on the monitor

The status of the monitor is set to [Display All Info.] in the default settings. When you change the [DISP Button] setting, and press DISP on the control wheel, the screen status will change to the viewfinder mode. You can also display the histogram by pressing DISP. The displayed contents and their position shown below are just a guideline, and may differ from the actual display.

Monitor mode

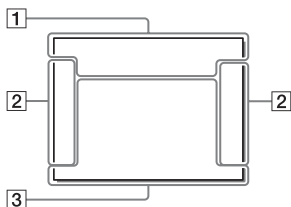

For playback

Basic information display

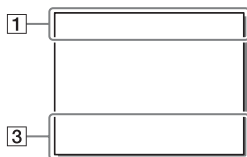

Viewfinder mode

Auto Mode or Scene Selection mode

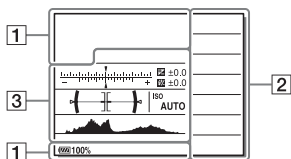

Histogram display

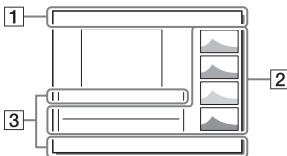

P/A/S/M/Sweep Panorama mode

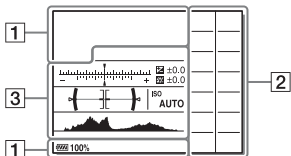

Display	Indication
	View Mode (65)
100-0003	Folder - file number
	Protect (43)
XAVC S HD AVCHD MP4	Recording mode of movies
DPOF	DPOF set
	Auto Object Framing
	Dual Video REC (36)
-PC-	PC Remote
	Bright Monitoring
	Write Copyright Information (44)













2



Display	Indication
	Drive mode (36)
	Flash mode (37)/Red-eye reduction (37)
	Flash compensation (37)
	Focus mode (70)

Display	Indication
	AF area (70)
	Face Detection/Smile Shutter (38)
	Metering mode (37)
	White balance (Auto, Preset, Custom, Color temperature, Color filter) (37)
7500K A5 G5	
	D-Range Optimizer/Auto HDR (71)
	LPF Effect (72)/LPF Effect switching notification
	Creative Style (71)/Contrast, Saturation, Sharpness
+3 +3 +3	
	Picture Effect (38)
	Smile detection sensitivity indicator
	Copyright Information

Display	Indication
PEAK HI PEAK MID PEAK LO PEAK OFF	Focus peaking (40)





3

Display	Indication
● Lock-on AF	Lock-on AF guide
-5+4+3+2+1+0+1+2+3+4+5+	Bracket indicator
 	Exposure compensation (37)/Metered Manual
STBY	Movie recording standby
REC 0:12	Recording time of the movie (m:s)
● (⊙) (⊙)	Focus
1/250	Shutter speed
F3.5	Aperture Value
ISO400 ISO AUTO	ISO sensitivity (37)
*	AE lock
	Shutter speed indicator
	Aperture indicator
	Histogram
	Digital level gauge
CH1  CH2 	Audio level (39)
 OFF    !	D-Range Optimizer/ Auto HDR/Auto HDR image warning
	Picture Effect error
2015-1-1 10:37PM	Date of recording

Display	Indication
3/7	File number/Number of images in the view mode
	Spot metering area
	Smart Telecon.
	Macro mode (62)

Functions that can be operated using the buttons/dials

You can set up or operate various functions using these buttons/dials. For the location of the buttons/dials, see “Identifying parts” (page 17).

Mode dial (67)	Switches the shooting mode.
MENU button (35)	Displays the menu screen for setting menu items.
MOVIE button (63)	Records movies.
AEL button/ button (65)	Fixes the exposure of the entire screen./Scales an image up when viewing images.
Fn button (33)/ button (65)	Displays the setup screen for functions set using the Fn button. In [For viewfinder] screen, switches to the Quick Navi screen./Displays multiple images on the screen simultaneously.
Exposure compensation dial	Sets the range for exposure adjustment.
 button (64)	Plays back images.
 button (66)/C2 button	Deletes images in playback mode./A frequently-used function can be assigned for shooting mode. No function is assigned to the button in the default settings.
C1 button	A frequently-used function can be assigned. Functions for shooting mode and playback mode can be assigned separately. The following function is assigned to each button in the default settings. For shooting: ISO For viewing: Follow Custom(Sht.)
Focus mode dial (70)	Selects the focus method to suit the movement of the subject.
Macro switching ring (62)	Switches to close-up shooting mode.
Aperture ring	Manually sets the aperture value (F-number).
Focusing ring	Adjusts the focus manually.
FINDER switch (22)	Raises the viewfinder.

How to use the Quick Navi screen

Using the Quick Navi screen, you can change settings directly on the recording information display when the screen mode is set to [For viewfinder] (Quick Navi).

1 MENU button → **⚙ (Custom Settings)** → **[DISP Button]** → **[Monitor]** → **[For viewfinder]** → **[Enter]**

2 Press the DISP on the control wheel to set the screen mode to [For viewfinder].

3 Press the Fn button to switch to the Quick Navi screen.

In Auto Mode or Scene Selection mode

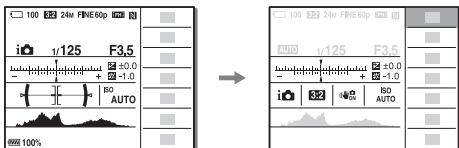

In P/A/S/M/Sweep Panorama mode







- The displayed contents and their position shown are just a guideline, and may differ from the actual display.

4 Select the desired item with ▲/▼/◀/▶ on the control wheel.

5 Set the item by turning the control wheel.

- Some setting values can be finely adjusted by turning the control dial.
- Pressing the center of the control wheel turns on the designated screen used to set up the selected item (page 32).
- Pressing the Fn button again turns off the Quick Navi screen and the screen goes back to the original one.

Functions available on the Quick Navi screen

Drive Mode	Flash Mode	Flash Comp.
Focus Area	Exposure Comp.	ISO
Metering Mode	White Balance	DRO/Auto HDR
Creative Style	Picture Effect	LPF Effect
Smile/Face Detect.	 Image Size	 Aspect Ratio
 Quality	 SteadyShot	Auto Mode
Scene Selection	Peaking Level	

Notes

- Gray items on the Quick Navi screen are not available.
- When using [Creative Style] (page 71), some of the setup tasks can be accomplished only on a designated screen.

Operating the camera

How to use the control wheel

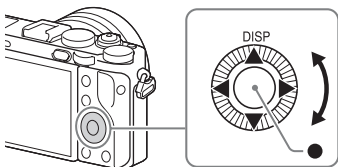

- You can turn the control wheel or press up/down/left/right on the control wheel to move the selection frame. Press ● in the center of the control wheel to set the selected item. In this manual, the action of pressing the up/down/left/right side of the control wheel is indicated by ▲/▼/◀/▶.
- The function to switch the display (DISP) is assigned to ▲ on the control wheel.
- You can assign a desired function to the ▼/◀/▶/● buttons and to the control wheel turning position in shooting mode.
- When you turn the control wheel or press ◀/▶ on the control wheel in playback mode, you can display the previous or next image.

How to use the control dial

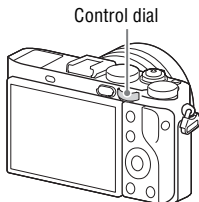

You can turn the control dial to change the settings required for each shooting mode with immediate effect.

Selecting a function using the Fn (Function) button

You can register frequently used functions to the Fn (function) button and recall them while shooting. Up to 12 frequently used functions can be registered to the Fn (Function) button.

1 Press the DISP on the control wheel to set the screen mode to other than [For viewfinder].

2 Press the Fn button.

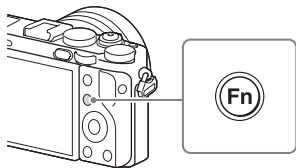

3 Select the desired item using ▲/▼/◀/▶ on the control wheel.

For a list of functions that can be registered and how to register them, see page 34.

4 Select the desired setting by turning the control wheel, then press ● on the control wheel.

- Some setting values can be finely adjusted by turning the control dial.

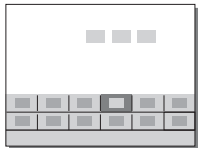

To set the individual settings in the dedicated screen

In step 3, select a setting item and press ● on the control wheel to switch to the dedicated screen for the setting item. Set the items according to the Operation guide.









Operation guide

Functions that can be registered using the Fn (Function) button

You can select the functions to be displayed when you press the Fn (Function) button.

MENU button →  (Custom Settings) → [Function Menu Set.]
→ **Assign the function to the desired location.**

The functions that can be selected using the Fn button are as follows:

Drive Mode	Selftimer during Brkt	Flash Mode
Flash Comp.	Focus Area	Exposure Comp.
ISO	ISO AUTO Min. SS	Metering Mode
White Balance	DRO/Auto HDR	Creative Style
Shoot Mode	Picture Effect	LPF Effect
Center Lock-on AF	Smile/Face Detect.	 Soft Skin Effect
 Auto Obj. Framing	 Image Size	 Aspect Ratio
 Quality	 SteadyShot	Audio Rec Level
Zebra	Grid Line	 Marker Display
Audio Level Display	Peaking Level	Peaking Color
Not set		

Functions that can be selected using the MENU button

You can set up the basic settings for the camera as a whole, or execute functions such as shooting, playback, or other operations.

1 Press the MENU button to display the menu screen.

2 Select the desired setting item using ▲/▼/◀/▶ on the control wheel or by turning the control wheel, and then press ● on the center of the control wheel.

- Select an icon at the top of the screen and press the ◀/▶ on the control wheel to move to another MENU item.

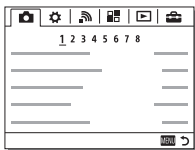

3 Select the setting value, then press ● to confirm.





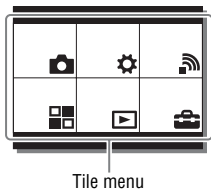

To display the Tile Menu

Allows you to select whether to always display the first screen of the menu when you press the MENU button.





MENU button →  (Setup) → [Tile Menu] → [On]





(Camera Settings)



 Image Size	Selects the size of still images. (L: 42M/M: 18M/S: 11M (3:2) L: 38M/M: 16M/S: 9.4M (4:3) L: 36M/M: 15M/S: 8.9M (16:9) L: 28M/M: 12M/S: 7.1M (1:1))
 Aspect Ratio	Selects the aspect ratio for still images. (3:2/4:3/16:9/1:1)
 Quality	Sets the image quality for still images. (RAW/RAW & JPEG/Extra fine/Fine/Standard)
 RAW File Type	Selects the file type for RAW images. (Compressed/Uncompressed)
Panorama: Size	Selects the size of panoramic images. (Standard/Wide)
Panorama: Direction	Sets the shooting direction for panoramic images. (Right/Left/Up/Down)
 File Format	Selects the movie file format. (XAVC S HD/AVCHD/MP4)
 Record Setting	Selects the quality and size of the recorded movie frame. For 1080 60i compatible models: (XAVC S HD: 60p 50M/30p 50M/24p 50M/120p 50M AVCHD: 60i 24M(FX)/60i 17M(FH)/60p 28M(PS)/24p 24M(FX)/24p 17M(FH) MP4: 1920×1080 60p 28M/1920×1080 30p 16M/1280×720 30p 6M) For 1080 50i compatible models: (XAVC S HD: 50p 50M/25p 50M/100p 50M AVCHD: 50i 24M(FX)/50i 17M(FH)/50p 28M(PS)/25p 24M(FX)/25p 17M(FH) MP4: 1920×1080 50p 28M/1920×1080 25p 16M/1280×720 25p 6M)
Dual Video REC	Sets whether to simultaneously record an XAVC S movie and MP4 movie or an AVCHD movie and MP4 movie. (On/Off)
Drive Mode	Sets the drive mode, such as for continuous shooting. (Single Shooting/Cont. Shooting/Spd Priority Cont./Self-timer/Self-timer(Cont)/Cont. Bracket/Single Bracket/WB bracket/DRO Bracket/LPF Bracket)

Bracket Settings	Sets self-timer shooting in bracket mode, shooting order for exposure bracketing, and white balance bracketing. (Selftimer during Brkt/Bracket order)
Flash Mode	Sets the flash settings. (Flash Off/Autoflash/Fill-flash/Slow Sync./Rear Sync./Wireless)
Flash Comp.	Adjusts the intensity of flash output. (-3.0EV to +3.0EV)
Red Eye Reduction	Reduces the red-eye phenomenon when using flash. (On/Off)
Focus Area	Selects the area of focus. (Wide/Center/Flexible Spot/Expand Flexible Spot/Lock-on AF)
 AF Illuminator	Sets the AF illuminator, which provides light for a dark scene to aid focusing. (Auto/Off)
Exposure Comp.	Compensates for the brightness of the entire image. (-5.0EV to +5.0EV)
ISO	Sets the ISO sensitivity. (Multi Frame NR/ISO AUTO/ISO 50 to ISO 102400)
ISO AUTO Min. SS	Sets the slowest shutter speed at which ISO sensitivity will start to change in [ISO AUTO] mode. (Faster/Fast/Standard/Slow/Slower/1/4000 - 30")
Metering Mode	Selects the method for measuring brightness. (Multi/Center/Spot)
White Balance	Adjusts the color tone of images. (Auto/Daylight/Shade/Cloudy/Incandescent/Fluor.: Warm White/Fluor.: Cool White/Fluor.: Day White/Fluor.: Daylight/Flash/C.Temp./Filter/Custom 1-3/Custom Setup)
DRO/Auto HDR	Compensates automatically for brightness and contrast. (Off/D-Range Opt./Auto HDR)
Creative Style	Selects the desired image processing. You can also adjust contrast, saturation, and sharpness. (Standard/Vivid/Neutral/Clear/Deep/Light/Portrait/Landscape/Sunset/Night Scene/Autumn leaves/Black & White/Sepia/Style Box 1-6)









Picture Effect	Shoots images with a texture unique to the selected effect. (Off/Toy Camera/Pop Color/Posterization/Retro Photo/Soft High-key/Partial Color/High Contrast Mono./Soft Focus/HDR Painting/Rich-tone Mono./Miniature/Watercolor/ Illustration)
Zoom	Sets the zoom scale for Clear Image Zoom and Digital Zoom.
Focus Magnifier	Enlarges the image before shooting so that you can check the focus.
 Long Exposure NR	Sets noise reduction processing for shots with a shutter speed of 1 second or longer. (On/Off)
 High ISO NR	Sets noise reduction processing for high-sensitivity shooting. (Normal/Low/Off)
LPF Effect	Sets the low pass filter effect. (Off/Standard/High)
Center Lock-on AF	Sets the function to track a subject and continue focusing when pressing the center button in the shooting screen. (Off/On)
Smile/Face Detect.	Selects to detect faces and adjust various settings automatically. Sets to automatically release the shutter when a smile is detected. (Off/On (Regist. Faces)/On/Smile Shutter)
 Soft Skin Effect	Sets the Soft Skin Effect and the effect level. (On: High/On: Mid/On: Low/Off)
 Auto Obj. Framing	Analyzes the scene when capturing faces, close-ups, or subjects tracked by Lock-on AF function, and automatically trims and saves another copy of the image with a more impressive composition. (Off/Auto)
Auto Mode	You can shoot selecting either Intelligent Auto or Superior Auto. (Intelligent Auto/Superior Auto)
Scene Selection	Selects pre-set settings to match various scene conditions. (Portrait/Sports Action/Landscape/Sunset/Night Scene/Hand-held Twilight/Night Portrait/Anti Motion Blur)
Movie	Selects the exposure mode to suit your subject or effect. (Program Auto/Aperture Priority/Shutter Priority/Manual Exposure)

 SteadyShot	Sets SteadyShot for shooting movies. Reduces blur from camera shake when shooting while holding the camera. (On/Off)
 Color Space	Changes the range of reproducible colors. (sRGB/AdobeRGB)
 Auto Slow Shut.	Sets the function that automatically adjusts the shutter speed following the brightness of the environment in movie mode. (On/Off)
Audio Recording	Sets whether to record audio when shooting a movie. (On/Off)
Audio Rec Level	Adjusts the audio recording level during movie recording. (0 to 31)
Wind Noise Reduct.	Reduces wind noise during movie recording. (On/Off)
Memory	Registers the desired modes or camera settings. (1 - 3)

(Custom Settings)

Zebra	Displays stripes to adjust brightness. (Off/70 to 100/100+)
 MF Assist	Displays an enlarged image when focusing manually. (On/Off)
Focus Magnif. Time	Sets the length of time the image will be shown in an enlarged form. (2 Sec/5 Sec/No Limit)
Grid Line	Sets a grid line display to enable alignment to a structural outline. (Rule of 3rds Grid/Square Grid/Diag. + Square Grid/Off)
 Marker Display	Sets whether to display the marker on the monitor when recording movies. (On/Off)
 Marker Settings	Sets the marker displayed on the monitor when recording movies. (Center/Aspect/Safety Zone/Guideframe)
Audio Level Display	Sets Audio Level Display. (On/Off)
Auto Review	Sets auto review to display the captured image after shooting. (10 Sec/5 Sec/2 Sec/Off)

DISP Button	Sets the type of information to be displayed on the monitor or in the viewfinder by pressing DISP on the control wheel. (Monitor/Finder)
Peaking Level	Enhances the outline of in-focus ranges with a specific color when focusing manually. (High/Mid/Low/Off)
Peaking Color	Sets the color used for the peaking function. (Red/Yellow/White)
Exposure Set. Guide	Sets the guide displayed when exposure settings are changed in the shooting screen. (Off/On)
Live View Display	Sets whether to reflect settings such as exposure compensation in screen display. (Setting Effect ON/Setting Effect OFF)
Disp. cont. AF area	Sets whether or not to display the focus area in [Continuous AF] mode. (On/Off)
Phase Detect. Area	Sets phase detection AF area. (On/Off)
 Pre-AF	Sets whether to perform auto focus before the shutter button is half pressed. (On/Off)
Zoom Setting	Sets whether to use the Clear Image Zoom and Digital Zoom when zooming. (Smart zoom only/On:ClearImage Zoom/On:Digital Zoom)
FINDER/MONITOR	Sets the method for switching between the viewfinder and the monitor. (Auto/Viewfinder(Manual)/Monitor(Manual))
Release w/o Card	Sets whether to release the shutter when a memory card is not inserted. (Enable/Disable)
Priority Set in AF-S	Sets the timing of the shutter release when the focus mode is set to [Single-shot AF] or [DMF]. (AF/Release/Balanced Emphasis)
Priority Set in AF-C	Sets the timing of the shutter release when the focus mode is set to [Continuous AF]. (AF/Release/Balanced Emphasis)

 AEL w/ shutter	Sets whether to adjust the exposure by pressing the shutter button halfway down. This is convenient when you want to adjust the focus and exposure separately. (Auto/On/Off)
Exp.comp.set	Sets whether to reflect exposure compensation value to flash compensation. (Ambient&flash/Ambient only)
Reset EV Comp.	Sets whether to retain the exposure value set without using the exposure dial, or reset the exposure value to 0 when you turn off the camera. (Maintain/Reset)
Face Registration	Registers or changes the person to be given priority in the focus. (New Registration/Order Exchanging/Delete/Delete All)
 Write Date	Sets whether to record a shooting date on the still image. (On/Off)
Lens Comp.	Compensates for distortion on the screen caused by the lens. (Shading Comp./Chro. Aber. Comp./Distortion Comp.)
Function Menu Set.	Customizes the functions displayed when the Fn (Function) button is pressed. (Drive Mode/Selftimer during Brkt/Flash Mode/Flash Comp./Focus Area/Exposure Comp./ISO/ISO AUTO Min. SS/Metering Mode/White Balance/ DRO/Auto HDR/ Creative Style/Shoot Mode/Picture Effect/LPF Effect/Center Lock-on AF/Smile/Face Detect./  Soft Skin Effect/  Auto Obj. Framing/  Image Size/  Aspect Ratio/  Quality/  SteadyShot/Audio Rec Level/Zebra/Grid Line/  Marker Display/Audio Level Display/Peaking Level/Peaking Color/Not set)
Custom Key(Shoot.)	Assigning functions to the various keys allows you to perform operations more quickly by pressing the keys when shooting images. (Control Wheel/Custom Button 1/Custom Button 2/Center Button/Left Button/Right Button/Down Button/AEL Button)
Custom Key(PB)	Assigning a function to the key allows you to perform operations more quickly by pressing the key when playing back images. (Custom Button 1)

MOVIE Button	Enables or disables for the MOVIE button. (Always/Movie Mode Only)
Dial / Wheel Lock	Sets whether to disable the control dial or control wheel by pressing and holding down the Fn button. (Lock/Unlock)

(Wireless)

Send to Smartphone	Transfers images to display on a smartphone. (Select on This Device/Select on Smartphone)
Send to Computer	Backs up images by transferring them to a computer connected to a network.
View on TV	You can view images on a network-enabled TV.
One-touch(NFC)	Assigns one application to One-touch (NFC). You can call up the application when shooting by touching an NFC-enabled Smartphone to the camera.
Airplane Mode	You can set this device to not perform wireless communications. (On/Off)
WPS Push	You can register the access point to the camera easily by pushing the Wi-Fi Protected Setup™ (WPS) button.
Access Point Set.	You can register your access point manually.
Edit Device Name	You can change the device name under Wi-Fi Direct, etc.
Disp MAC Address	Displays the MAC address of the camera.
SSID/PW Reset	Resets the SSID and password of smartphone connection.
Reset Network Set.	Reset all network settings.

(Application)

You can connect to the PlayMemories Camera Apps™ download site via the Internet to add desired functions to your camera.

- This camera is preinstalled with a built-in application called [Smart Remote Embedded] that allows you to control the camera using your smartphone. The preinstalled application [Smart Remote Embedded] will not be deleted even if you select MENU button →  (Setup) → [Setting Reset] → [Initialize].

 **(Playback)**

Delete	Deletes an image. (Multiple Img./All in this Folder/All with this date)
View Mode	Plays back images from a specified date or specified folder of still images and movies. (Date View/Folder View(Still)/Folder View(MP4)/AVCHD View/XAVC S HD View)
Image Index	Displays multiple images at the same time. (9 Images/25 Images)
Display Rotation	Sets the playback direction of the recording image. (Auto/Manual/Off)
Slide Show	Shows a slide show. (Repeat/Interval)
Rotate	Rotates the image.
 Enlarge Image	Enlarges the playback images.
4K Still Image PB	Outputs still images in 4K resolution to an HDMI connected TV that supports 4K.
Protect	Protects the images. (Multiple Img./All in this Folder/All with this date/Cancel All in this Folder/Cancel All with this date)
Specify Printing	Adds a print order mark to a still image. (Multiple Img./Cancel All/Print Setting)

 **(Setup)**

Monitor Brightness	Sets the monitor brightness. (Auto/Manual/Sunny Weather)
Viewfinder Bright.	Sets the brightness of the electronic viewfinder. (Auto/Manual)
Finder Color Temp.	Sets the color temperature of the viewfinder.
Volume Settings	Sets the volume for movie playback.
Audio signals	Sets whether to sound a beep during auto focus or self-timer operations. (On/Shutter/Off)
Upload Settings	Sets the upload function of the camera when using an Eye-Fi card. (On/Off)

Tile Menu	Sets whether to display the tile menu every time you press the MENU button. (On/Off)
Mode Dial Guide	Turns the mode dial guide (the explanation of each shooting mode) on or off. (On/Off)
Delete confirm.	Sets whether Delete or Cancel is preselected in the Delete confirmation screen. ("Delete" first / "Cancel" first)
Display Quality	Sets the display quality. (High/Standard)
Pwr Save Start Time	Sets the time intervals to automatically switch to power save mode. (30 Min/5 Min/2 Min/1 Min/10 Sec)
NTSC/PAL Selector*	By changing the TV format of the device, shooting in a different movie format is possible.
Demo Mode	Sets demonstration playback of a movie to on or off. (On/Off)
HDMI Settings	Sets the HDMI settings. (HDMI Resolution/  24p/60p Output/HDMI Info. Display/CTRL FOR HDMI)
USB Connection	Sets the USB connection method. (Auto/Mass Storage/MTP/PC Remote)
USB LUN Setting	Enhances compatibility by limiting the functions of USB connection. Set to [Multi] in normal conditions and to [Single] only when the connection between the camera and a computer or AV component cannot be established. (Multi/Single)
USB Power Supply	Sets whether to supply power via USB connection when the camera is connected to a computer or USB device using a micro USB cable. (On/Off)
Language	Selects the language.
Date/Time Setup	Sets date and time, and daylight savings.
Area Setting	Sets the location of use.
Copyright Info	Sets copyright information for still images. (Write Copyright Info/Set Photographer/Set Copyright/Disp. Copyright Info)
Format	Formats the memory card.

File Number	Sets the method used to assign file numbers to still images and movies. (Series/Reset)
Select REC Folder	Changes the selected folder for storing still images and movies (MP4).
New Folder	Creates a new folder for storing still images and movies (MP4).
Folder Name	Sets the folder format for still images. (Standard Form/Date Form)
Recover Image DB	Recovers the image database file and enables recording and playback.
Display Media Info.	Displays the remaining recording time of movies and the recordable number of still images on the memory card.
Version	Displays the camera software version.
Certification Logo*²	The certification can be displayed on the camera.
Setting Reset	Restores settings to their defaults. Select [Initialize] to restore all settings to their default values. (Initialize/ Camera Settings Reset)

*1 [NTSC/PAL Selector] is only available for models that have AVCHD 50i recording as a default setting.

If you switch this item, it will be required to format the memory card in the setting compatible with the PAL or NTSC system respectively. Also, note that it may not be possible to play back movies recorded with the NTSC system on a PAL system TV.

*2 For some models only

Using the In-Camera Guide

You can use [Custom Key(Shoot.)] to assign In-Camera Guide to the desired button.

The In-Camera Guide displays explanations for the currently selected menu function or setting.

**MENU button → ⚙ (Custom Settings) → [Custom Key(Shoot.)]
→ Select the desired button assigned to the function. → [In-Camera Guide]**

Press the MENU button and use the control wheel to select a MENU item whose explanation you want to read, and then press the button to which [In-Camera Guide] is assigned.

Charging the battery pack

When using the camera for the first time, be sure to charge the battery pack. The charged battery pack is discharged little by little, even when you do not use it. To avoid missing an opportunity to shoot, charge the battery pack again before you shoot.

Charging the battery pack using the battery charger

1 Insert the battery pack into the battery charger.

- Slide the top cover of the battery charger to open it, and then insert the battery pack until it clicks by aligning the ▼ marks on both the battery pack and the battery charger.

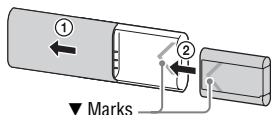

2 Slide the top cover of the battery charger to close it.

3 Connect the battery charger to the AC Adaptor (supplied) using the micro USB cable (supplied), and connect the AC Adaptor to a wall outlet (wall socket). Alternatively, you can charge the battery from a computer by connecting the battery charger to a USB jack on a computer connected to a power source.

- The CHARGE lamp lights orange when charging is started.
- The CHARGE lamp turns off when charging is finished.
- If the CHARGE lamp lights up and then immediately turns off, the battery pack is fully charged.
- For some countries/regions, connect the power cord to the AC Adaptor and then connect the AC Adaptor to a wall outlet (wall socket) when you charge the battery pack using the AC Adaptor.

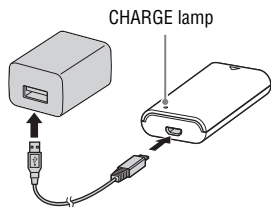

Notes

- If the CHARGE lamp does not light up, check if the battery pack is firmly attached to the battery charger, and then disconnect and reconnect the micro USB cable.
- Connect the battery charger directly to the computer, not via a USB hub, etc.

Charging the battery pack using the camera

- 1 Set the ON/OFF (Power) switch to OFF.**

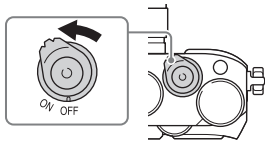

- 2 Slide the lever to open the cover.**

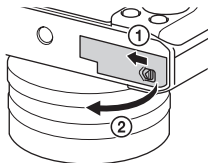

- 3 Insert the battery pack completely, using the tip of the battery to press the lock lever.**

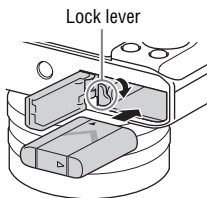

4 Close the cover.

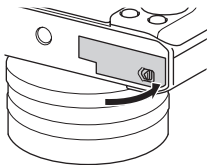

5 Connect the camera to the AC Adaptor (supplied) using the micro USB cable (supplied), and connect the AC Adaptor to the wall outlet (wall socket).

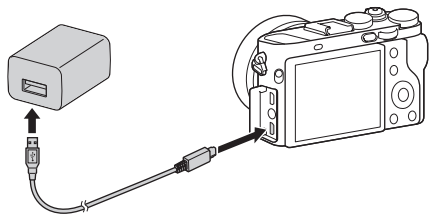

The charge lamp lights orange, and charging starts.

- Turn off the camera while charging the battery.
- If the charge lamp lights up and then immediately turns off, the battery pack is fully charged.
- When the charge lamp flashes and charging is not finished, remove and re-insert the battery pack.
- For some countries/regions, connect the power cord to the AC Adaptor and then connect the AC Adaptor to a wall outlet (wall socket).

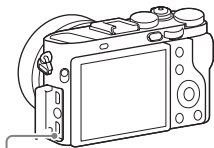

Charge lamp
 Lit: Charging
 Off: Charging finished
 Flashing:

Charging error or charging paused temporarily because the camera is not within the proper temperature range

Notes

- If the charge lamp on the camera flashes when the AC Adaptor is connected to the wall outlet (wall socket), this indicates that charging is temporarily stopped because the temperature is outside the recommended range. When the temperature gets back within the appropriate range, the charging resumes. We recommend charging the battery pack in an ambient temperature of between 10°C to 30°C (50°F to 86°F).
- Connect the AC Adaptor (supplied) to the nearest wall outlet (wall socket). If malfunctions occur while using the AC Adaptor, disconnect the plug from the wall outlet (wall socket) immediately to disconnect from the power source.
- When the camera is being used for the first time or when you use a battery pack that has not been used for a long time, the charge lamp/CHARGE lamp may flash quickly when the battery is charged for the first time. If that happens, remove the battery pack from the camera and then re-insert it to recharge.
- Do not continuously or repeatedly charge the battery without using it if it is already fully charged or close to fully charged. Doing so may cause a deterioration in battery performance.
- When charging is finished, disconnect the AC Adaptor from the wall outlet (wall socket).
- Be sure to use only genuine Sony brand battery packs, micro USB cable (supplied) and AC Adaptor (supplied).

Charging time (Full charge)

The charging time is approximately 155 min. using the AC Adaptor (supplied) with the battery charger (supplied), and approximately 150 min. using the AC Adaptor with the camera.

Notes

- The above charging time applies when charging a fully depleted battery pack at a temperature of 25°C (77°F). Charging may take longer depending on conditions of use and circumstances.

Charging by connecting to a computer

The battery pack can be charged by connecting the camera to a computer using a micro USB cable. Connect the camera to the computer with the camera turned off.

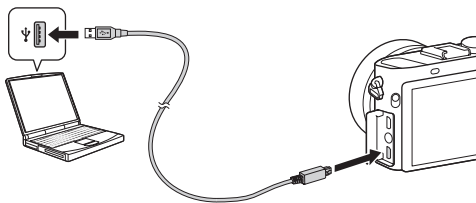

Notes

- If the camera is connected to a laptop computer that is not connected to a power source, the laptop battery level decreases. Do not charge for an extended period of time.
- Do not turn on/off or restart the computer, or wake the computer to resume from sleep mode when a USB connection has been established between the computer and the camera. The camera may cause a malfunction. Before turning on/off, or restarting the computer or waking the computer from sleep mode, disconnect the camera and the computer.
- No guarantees are made for charging using a custom-built computer or a modified computer.

Checking the remaining battery charge

A remaining charge indicator appears on the screen.



Notes

- The remaining charge indicator may not be correct under certain circumstances.

Supplying power from a wall outlet (wall socket)

You can use the camera while power is supplied from a wall outlet (wall socket) by using the AC Adaptor (supplied).

1 Insert the battery pack into the camera (page 48).

2 Connect the camera to a wall outlet (wall socket) using the micro USB cable (supplied) and the AC Adaptor (supplied).

Notes

- The camera will not activate if there is no remaining battery. Insert a sufficiently charged battery pack into the camera.
- If you use the camera while power is being supplied from a wall outlet (wall socket), make sure that the icon () displays on the monitor.
- Do not remove the battery pack while power is being supplied from a wall outlet (wall socket). If you remove the battery pack, the camera will turn off.
- Do not remove the battery pack while the access lamp (page 21) is lit. The data on the memory card may be damaged.
- As long as the power is on, the battery pack will not be charged even if the camera is connected to the AC Adaptor.
- Under certain conditions, power may be supplied from the battery supplementarily even if you are using the AC Adaptor.
- While power is being supplied via USB connection, the temperature inside the camera may rise, shortening the continuous recording duration.
- When using a mobile charger as a power source, confirm that it is fully charged before use. Also, be careful of the remaining power on the mobile charger during use.

To remove the battery pack

Turn off the camera. Slide the lock lever after confirming that the access lamp (page 21) is off, and remove the battery pack.

Be sure not to drop the battery pack.

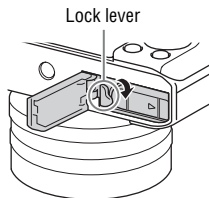

Inserting a memory card (sold separately)

1 Slide the lever to open the cover.

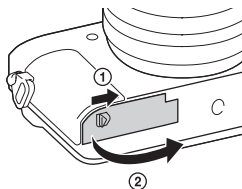

2 Insert the memory card.

- With the notched corner facing as illustrated, insert the memory card until it clicks into place.

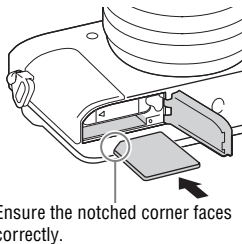

3 Close the cover.

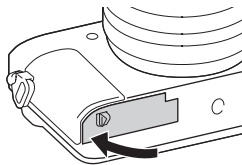

To remove the memory card

Make sure that the access lamp (page 21) is not lit, then push the memory card in once.

Formatting the memory card

When you use a memory card with the camera for the first time, it is recommended that you format (initialize) the card on the camera for more stable performance of the memory card.

- Formatting will erase all data on the memory card permanently, and is irreversible. Save valuable data on a computer, etc.
- To perform formatting, select MENU button →  (Setup) → [Format].

Memory cards that can be used

You can use the following types of memory cards with this camera. However, proper operation cannot be guaranteed for all types of memory cards.

Memory card	For still images	For movies		
		MP4	AVCHD	XAVC S
Memory Stick PRO Duo	✓	✓ (Mark2 only)	✓ (Mark2 only)	—
Memory Stick PRO-HG Duo™	✓	✓	✓	—
Memory Stick Micro™ (M2)	✓	✓ (Mark2 only)	✓ (Mark2 only)	—
SD memory card	✓	✓*1	✓*1	—
SDHC memory card				
SDXC memory card	✓	✓*1	✓*1	✓*2
microSD memory card	✓	✓*1	✓*1	—
microSDHC memory card				
microSDXC memory card	✓	✓*1	✓*1	✓*2

*1 SD Speed Class 4: **CLASS 4** or faster, or UHS Speed Class 1: **U1** or faster

*2 Memory cards that fulfill all of the following conditions:

- Capacity of 64 GB or more
- SD Speed Class 10: **CLASS 10**, or UHS Speed Class 1: **U1** or faster

- For details on the number of recordable still images and recordable duration of movies, refer to pages 81 to 83. Check the tables to select a memory card with the desired capacity.

Notes

- Not all memory cards are guaranteed to operate correctly. For memory cards produced by manufacturers other than Sony, consult the manufacturers of the products.
- When using Memory Stick Micro media or microSD memory cards with this camera, make sure to use with the appropriate adaptor.
- Images recorded on an SDXC memory card cannot be imported to or played on computers or AV devices that are not compatible with exFAT*. Make sure that the device is compatible with exFAT before connecting it to the camera. If you connect your camera to an incompatible device, you may be prompted to format the card. Never format the card in response to this prompt, as doing so will erase all data on the card.

* exFAT is the file system used on SDXC memory cards.

Setting the language and the clock

When you turn the camera on for the first time or after you initialize the functions, the language, date and time setting screen will appear.

1 Set the ON/OFF (Power) switch to ON to turn on the camera.

A screen will appear that lets you set the language to be used on the monitor.

- To turn the camera off, set the ON/OFF (Power) switch to OFF.

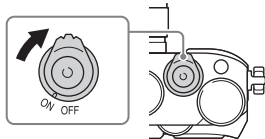

2 Select a desired language, then press ● on the control wheel.

The screen to set the date and time appears.

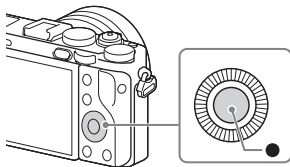

3 Check that [Enter] is selected on the screen, then press ●.

4 Select a desired geographic location, and then press ●.

5 Press ▲/▼ on the control wheel, or select a setting item by turning the control wheel, then press ●.

6 Press ▲/▼/◀/▶, or select a desired setting by turning the control wheel, then press ●.

7 Repeat steps 5 and 6 to set other items, then select [Enter] and press ● on the control wheel.

To cancel the date and time setting operation

Press the MENU button.

Checking or resetting the date/time and area

The date and time setup screen appears automatically when the power is turned on for the first time or when the internal rechargeable backup battery has been discharged. To reset the date and time, use the menu.

MENU button →  **(Setup)** →
[Date/Time Setup] or [Area Setting]

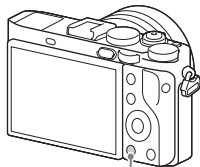

MENU button

Maintaining the date and time setting

This camera has an internal rechargeable battery for maintaining the date and time and other settings regardless of whether the power is on or off, or the battery is installed or not.

Shooting a clear image without camera shake

“Camera shake” refers to unwanted movement of the camera that occurs after the shutter button has been pressed, resulting in a blurred image.

Holding the camera properly

Stabilize your upper body and take a position that keeps the camera from moving.

Viewfinder mode



Viewfinder mode
(vertical position)



Monitor mode



Point ①

One hand holds the grip of the camera, and the other hand supports the lens.

Point ②

Take a secure stance with your feet shoulder-width apart.

Point ③

Lightly tuck your elbows against your body.

When shooting in a kneeling position, steady your upper body by placing your elbow on your knee.

SteadyShot function for movie shooting

This camera is equipped with the SteadyShot function, which reduces camera shake during movie recording. The SteadyShot function is activated only when recording movies.

MENU button →  **(Camera Settings)** →  **SteadyShot** →
Select the desired setting.

Notes

- The SteadyShot function is available only for movie shooting. You cannot use the SteadyShot function for shooting still images.

Shooting still images

In [Auto Mode], the camera analyzes the subject and allows you to shoot with the appropriate settings.

1 Set the ON/OFF (Power) switch to ON to turn on the camera.

2 Set the mode dial to **AUTO (Auto Mode).**

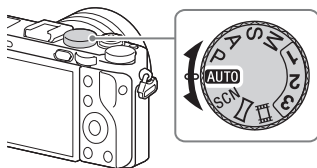

3 Hold the camera, and then decide on your composition.

4 Press the shutter button halfway down to focus.

- When the image is in focus, the ● or (●) indicator lights.

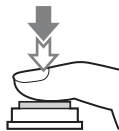

5 Press the shutter button fully down to shoot an image.

- If [Auto Obj. Framing] is set to [Auto], when shooting faces, close-up (macro) subjects, or subjects tracked by Lock-on AF, the camera analyzes the scene and automatically trims the captured image into a suitable composition. Both the original and the trimmed images will be saved.
-

Shooting techniques

- When you turn the macro switching ring to “0,2m-0,35m,” the camera is set to macro mode. The shortest shooting distance is approximately 0.2 m (0.65 ft.). Macro mode is suitable for shooting close-ups of subjects such as flowers or food.

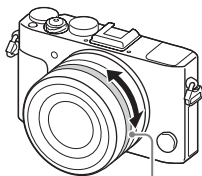

Macro switching ring

Recording movies

1 Press the MOVIE button to start recording.

- Since the [MOVIE Button] is set to [Always] in the default setting, movie recording can be started from any shooting mode.

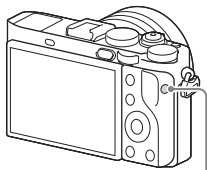

MOVIE button

2 Press the MOVIE button again to stop recording.

Notes

- The sound of the camera in operation may be recorded while recording a movie. You can disable the sound recording by setting [Audio Recording] to [Off] (page 39).
- The continuous recording time of a movie depends on the ambient temperature or the condition of the camera. See “Notes on continuous movie recording” (page 84).
- When the [H] icon appears, the temperature of the camera is too high. Turn the camera off and wait until the temperature of the camera decreases.
- When you are recording continuously for a long time, you may feel that the camera is warm. This is normal. Also, [Internal temp. high. Allow it to cool.] may appear. In such cases, turn the camera off and wait until the camera is ready to shoot again.
- When shooting, the sound of the shoulder strap hooks (triangular hook) could be recorded, depending on the situation used.

Playing back images



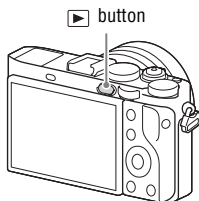









1 Press the  button.



2 Select an image by pressing the  on the control wheel.

- To play back movies, press  on the control wheel.

If you press  on the control wheel while playing back a movie, the control panel will be displayed.

Control panel	Action during movie playback
	Playback
	Pause
	Fast forward
	Fast rewind
	Forward slow playback
	Rewind slow playback
	Next movie
	Previous movie
	Frame advance
	Frame rewind
	Volume settings
	Closes the control panel

Notes

- Movies recorded using other devices may not play back on this camera.

Switching between still images and movies



To play back still images, set [View Mode] to [Folder View(Still)], and to play back movies, set [View Mode] to [Folder View(MP4)], [AVCHD View] or [XAVC S HD View]. When you select [Date View], both still images and movies will be displayed on the screen, sorted by date.

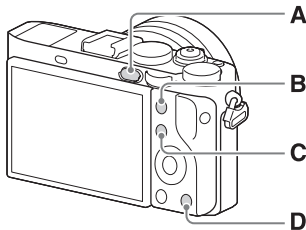

MENU button →  (**Playback**) → **[View Mode]** → **Select the desired mode.**

Playback functions

Convenient functions for playback are as follows:



- A**  Changes to the playback screen.
- B**  Magnifies or reduces images.
- Turn the control wheel to magnify or reduce an image. Turn the control dial to switch to the next/previous image.

- C**  Image index screen
- You can select the number of images to be displayed:
MENU button →  (**Playback**) → [Image Index]

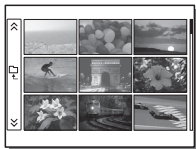

- D**  Deletes unnecessary images.

Deleting images

Once you have deleted an image, you cannot restore it. Be sure that you want to delete the image before proceeding.

-
- 1** While displaying the image you want to delete, press the  (Delete) button.

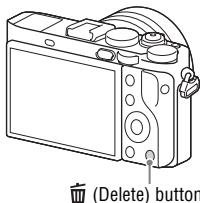

-
- 2** Select [Delete] with ▲/▼ on the control wheel, then press ●.

- To delete several images at a time, select MENU button →  (Playback) → [Delete].

Notes



- Protected images cannot be deleted.

Selecting a shooting mode

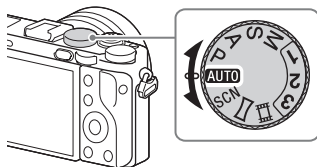
Turn the mode dial and set to the desired shooting mode.

















The following shooting modes are available.

AUTO (Auto Mode)	Allows you to shoot still images with the settings adjusted automatically.
P (Program Auto)	Allows you to shoot with the exposure (the shutter speed and the aperture value) adjusted automatically. The other settings can be adjusted manually.
A (Aperture Priority)	Shoots by adjusting the aperture and changing the focus range, or by defocus the background.
S (Shutter Priority)	Adjusts the shutter speed to show the movement of the subject.
M (Manual Exposure)	Allows you to shoot after manually adjusting the exposure (the shutter speed and the aperture value) using the control dial and the aperture ring.
1/2/3 (Memory recall)	Calls up settings pre-registered in [Memory] in the  (Camera Settings).
SCN (Scene Selection)	Allows you to shoot with preset settings according to the scene.
 (Sweep Panorama)	Allows you to shoot panoramic images by combining multiple images.
 (Movie)	Allows you to change shooting settings and shoot a movie.

Functions available for each shooting mode

The functions you can use depend on the selected shooting mode.

In the table below, ✓ indicates the function is available, and a – indicates the function is not available.

Shoot Mode		Exposure Comp.	Self-timer	Cont. Shooting	Face Detection	Smile Shutter	Auto Obj. Framing
AUTO	   	–	✓	✓	✓	✓	✓
SCN		–	✓	–	✓	✓	✓
		–	–	✓	✓	✓	–
		–	✓	–	–	–	✓
		–	✓	–	–	–	✓
		–	✓	–	–	–	✓
		–	✓	–	✓	–	–
		–	✓	–	✓	✓	✓
		–	✓	–	✓	–	–
	✓	–	–	–	–	–	
P		✓	✓	✓	✓	✓	✓
A		✓	✓	✓	✓	✓	✓
S		✓	✓	✓	✓	✓	✓
M		–*	✓	✓	✓	✓	✓
		✓*	–	–	✓	–	–

* When the shooting mode is set to M, the exposure can be adjusted only when [ISO] is set to [ISO AUTO].

Using the various functions

This manual mainly provides an introduction on the use of the camera and a list of functions. To learn more about the camera, refer to “Help Guide” (page 2), which offers in-depth instructions on the many functions.

Image Size (still image)

The larger the image size, the more detail will be reproduced when the image is printed on large-format paper. The smaller the image size, the more images can be recorded.

MENU button →  (Camera Settings) →  Image Size → **Select the desired setting.**

When [Aspect Ratio] is 3:2		When [Aspect Ratio] is 4:3	
L:42M	7952 × 5304 pixels	L:38M	7072 × 5304 pixels
M:18M	5168 × 3448 pixels	M:16M	4592 × 3448 pixels
S:11M	3984 × 2656 pixels	S:9.4M	3536 × 2656 pixels
When [Aspect Ratio] is 16:9		When [Aspect Ratio] is 1:1	
L:36M	7952 × 4472 pixels	L:28M	5296 × 5296 pixels
M:15M	5168 × 2912 pixels	M:12M	3440 × 3440 pixels
S:8.9M	3984 × 2240 pixels	S:7.1M	2656 × 2656 pixels

Notes

- When  Quality is set to [RAW] or [RAW & JPEG], the image size for RAW images corresponds to [L].

Auto focus functions

[Focus Mode]: You can select the focus method to suit the movement of the subject.

Set the focus mode dial to S (Single-shot AF) or C (Continuous AF).

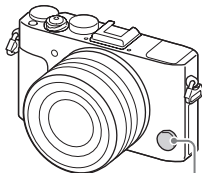





Focus mode dial

S (Single-shot AF)	The product locks the focus when the focus adjustment is achieved. Use this when the subject is motionless.
C (Continuous AF)	The product continues to focus while the shutter button is pressed and held halfway down. Use this when the subject is in motion.

[Focus Area]: You can select the focusing area. Use this function when it is difficult to get the proper focus in auto focus mode.

MENU button →  (Camera Settings) → [Focus Area] → Select the desired setting.

 (Wide)	Focuses automatically on a subject in all ranges of the image.
 (Center)	Focuses automatically on a subject in the center of the image.
 (Flexible Spot)	Allows you to move the AF range frame to the desired point on the screen and focus on an extremely small subject in a narrow area.
 (Expand Flexible Spot)	If the product fails to focus on the single selected point, it uses the focus points around the flexible spot as the second priority area to achieve focus.

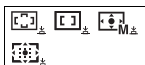
 <p>(Lock-on AF)</p>	<p>When the shutter button is pressed and held halfway down, the product tracks the subject within the selected autofocus area. Point the cursor to [Lock-on AF] on the [Focus Area] setting screen, then select the desired tracking start area using the left/right sides of the control wheel.</p> <p>You can move the tracking start area to any desired point by designating the area as a flexible spot or an expanding flexible spot.</p>
--	--

Creative Style

You can select the desired kind of image processing from among 13 styles, and you can also adjust the contrast, saturation, and sharpness for each [Creative Style] item.

MENU button →  **(Camera Settings)** → **[Creative Style]** → **Select the desired style.**

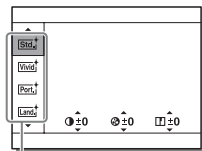

[Creative Style] item

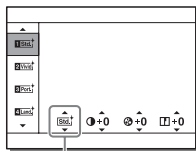

[Style Box]

You can fine-tune the setting and save the adjusted setting.

DRO/Auto HDR

Using the [DRO/Auto HDR] function, you can capture various gradations of the contrast of images.

MENU button →  **(Camera Settings)** → **[DRO/Auto HDR]** → **Select the desired setting.**



[D-Range Opt.]: By dividing the image into small areas, the camera analyses the contrast of light and shadow between the subject and the background, and produces an image with the optimal brightness and gradation.

[Auto HDR]: Shoots 3 images with different exposures, and then overlays the correctly exposed image, the bright areas of an under exposed image and the dark areas of an over exposed image to create an image with rich gradation.





LPF Effect

This camera is equipped with an optical variable low pass filter. By changing the low pass filter effect settings according to your subject, you can choose whether to prioritize the resolution or to reduce moiré patterns and false colors.

MENU button →  **(Camera Settings)** → **[LPF Effect]** → **Select the desired setting.**

 (Off)	The low pass filter effect is not used. The resolution is prioritized.
 (Standard)	Balances the resolution with the reduction of moiré patterns and false colors.
 (High)	Prioritizes the reduction of moiré patterns and false colors.

Notes

- Depending on the camera settings and subject, you may not be able to get the result you want.
- While the camera is changing the setting,  is displayed on the monitor. You can shoot images while the  is displayed, but the [LPF Effect] settings may not be executed properly. For images shot while the  is displayed,  is displayed on the playback screen.
- [LPF Effect] is locked to [Off] and cannot be changed when the shooting mode is set to one of the following modes:
 - [Intelligent Auto]
 - [Superior Auto]
 - [Scene Selection]
 - [Sweep Panorama]
 - [Movie]

Using the Wi-Fi and NFC one-touch functions

You can perform the following operations using the camera's Wi-Fi and NFC One-touch functions.

Saving images to a computer.



Transferring images from the camera to a smartphone.



Using the smartphone as a remote control for the camera.



Viewing still images on a TV.



For details on the Wi-Fi and NFC One-touch functions, refer to the attached document “Wi-Fi Connection/One-touch (NFC) Guide” or to the “Help Guide” (page 2).

Connecting the camera to a wireless access point

Connect the camera to your wireless access point. Before starting the procedure, make sure you have the SSID (name of the access point) and password of your wireless access point with you.

1 MENU button →  (Wireless) → [Access Point Set.]

2 Use ▲/▼ on the control wheel to select the access point you want to connect to. Press ● in the center of the control wheel and enter the password if a key icon is displayed with a wireless access point, then select [OK].

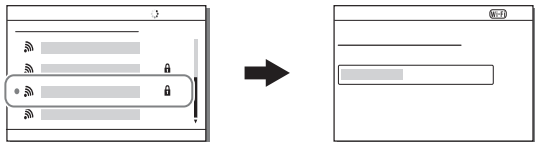

Notes

- If a connection is not established, see the wireless access point operating instructions or contact the administrator of the access point.
- To save images to a computer, install the following dedicated software on your computer.

When using Windows: PlayMemories Home

<http://www.sony.net/pm/>

When using Mac: Wireless Auto Import

<http://www.sony.co.jp/imsoft/Mac/>

Adding applications to the camera (PlayMemories Camera Apps)

You can add the desired functions to your camera by connecting to the application downloading website  (PlayMemories Camera Apps) via the Internet.

Downloading applications

1 Access the application downloading website.

<http://www.sony.net/pmca/>

- For more information on the computer environment required for downloading, refer to the application download website.

2 Follow the instructions on the screen to obtain a service account (first time only).

- If you have an account, sign in to the application download site.

3 Select the desired application and download the application to the camera following the instructions on the screen.

- Connect the computer and the camera using the micro USB cable (supplied), following the instructions on the screen.

① To a USB terminal of the computer

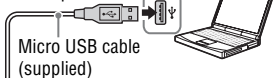

Micro USB cable (supplied)

② Multi/Micro USB Terminal

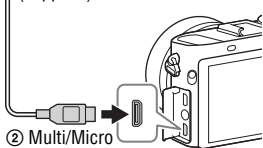

Notes

- The application downloading function may not be available in some countries and regions. For details, refer to the application downloading website above.

How to download applications directly using the Wi-Fi function of the camera



You can download applications using the Wi-Fi function without connecting to a computer.

Select MENU button →  (Application) → [Application List] →  (PlayMemories Camera Apps), then follow the instructions on the screen to download applications.

- Acquire a service account in advance.
- Select MENU button →  (Wireless) → [Access Point Set.] → access point to be connected → change [IP Address Setting] to [Auto] if it is set to [Manual].

Launching the application

MENU button →  (Application) → [Application List] → Select the desired application to launch.

- You can use the [One-touch(NFC)] menu to install NFC one-touch functions and call up the applications by simply touching the smartphone to the  mark on the camera.
- Before using the NFC One-touch functions, set the applications that you want to call up using the following procedure:
MENU button →  (Wireless) → [One-touch(NFC)] → desired application
After displaying the shooting screen on the camera, touch the smartphone to the camera.
- “Smart Remote Embedded” is assigned to [One-touch(NFC)] in the default setting.

Developing RAW images (Image Data Converter)

With Image Data Converter, you can do the following:

- You can play back and edit images recorded in RAW format with various corrections, such as tone curve and sharpness.
- You can adjust images with white balance, exposure, and [Creative Style], etc.
- You can save the images displayed and edited on a computer. You can either save the image as RAW format or save it in a general file format.
- You can display and compare the RAW images and JPEG images recorded by this camera.
- You can rank images in 5 grades.
- You can apply color labels.

Installing Image Data Converter

Using the Internet browser on your computer, go to the following URL, and then follow the instructions on the screen to download Image Data Converter.

<http://www.sony.co.jp/ids-se/>

- An Internet connection is required.
- For details on operation, refer to the following Image Data Converter support page (English only):
<http://www.sony.co.jp/ids-se/>
- You can also check the details from “Help” in the menu bar of Image Data Converter.

Importing images to your computer and using them (PlayMemories Home)

The software PlayMemories Home allows you to import still images and movies to your computer and use them. PlayMemories Home is required for importing XAVC S movies or AVCHD movies to your computer.



Importing images from your camera

Playing back imported images



For Windows, the following functions are also available:



Viewing images on a calendar



Creating movie discs



Uploading images to network services

Sharing images on PlayMemories Online™



- You can download Image Data Converter or Remote Camera Control, etc. by performing the following procedure:

Connect the camera to your computer → launch PlayMemories Home → click [Notifications].

Notes

- An Internet connection is required to use PlayMemories Online or other network services. PlayMemories Online or other network services may not be available in some countries or regions.
- Refer to the following URL for Mac software:
<http://www.sony.co.jp/imsoft/Mac/>
- If the software PMB (Picture Motion Browser), supplied with models released before 2011, has already been installed on your computer, it will be overwritten by PlayMemories Home during the installation. Use PlayMemories Home, the successor software of PMB.

- Movies recorded using the [60p 28M(PS)]/[50p 28M(PS)], [60i 24M(FX)]/[50i 24M(FX)] or [24p 24M(FX)]/[25p 24M(FX)] setting in [Record Setting] are converted by PlayMemories Home to create an AVCHD recording disc. This conversion can take a long time. Also, you cannot create a disc with the original image quality. If you want to keep the original image quality, store your movies on a Blu-ray Disc.

Installing PlayMemories Home

Using the Internet browser on your computer, go to the following URL, and then follow the instructions on the screen to download PlayMemories Home.

<http://www.sony.net/pm/>

- An Internet connection is required.
- For details on operation, refer to the following PlayMemories Home support page (English only):

<http://www.sony.co.jp/pmh-se/>

To add functions to PlayMemories Home

When you connect the camera to your computer, new functions may be added to PlayMemories Home. It is recommended that you connect the camera to your computer even if PlayMemories Home has already been installed on the computer.

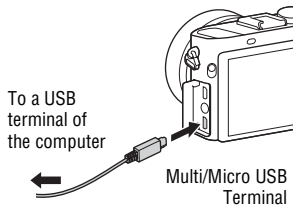

Controlling the camera using your computer (Remote Camera Control)

Connect the camera to your computer. With Remote Camera Control you can:

- Set up the camera or record an image from the computer.
- Record an image directly to the computer.
- Perform an Interval Timer Shooting.

Set up the following before use: MENU button →  (Setup) → [USB Connection] → [PC Remote]

Installing Remote Camera Control

Using the Internet browser on your computer, go to the following URL, and then follow the instructions on the screen to download Remote Camera Control.

Windows:

<http://www.sony.co.jp/imsoft/Win/>

Mac:

<http://www.sony.co.jp/imsoft/Mac/>

- An Internet connection is required.
- For details on operation, refer to the Help.

Checking the number of images and recordable time of movies

When you insert a memory card into the camera and set the ON/OFF (Power) switch to ON, the number of images that can be recorded (should you continue to shoot using the current settings) is displayed on the screen.

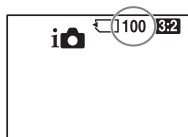

Notes

- When “0” (the number of recordable images) flashes in yellow, the memory card is full. Replace the memory card with another one, or delete images from the current memory card (pages 43, 66).
- When “NO CARD” (the number of recordable images) flashes in yellow, it means no memory card has been inserted. Insert a memory card.

The number of images that can be recorded on a memory card

The table below shows the approximate number of images that can be recorded on a memory card formatted with this camera. The values are defined using Sony standard memory cards for testing. The values may vary depending on the shooting conditions and the type of memory card used.

Image Size: L: 42M

Aspect Ratio: 3:2*

Memory card formatted with this camera

(Units: Images)

Quality \ Capacity	8 GB	16 GB	32 GB	64 GB
Standard	770	1550	3100	6200
Fine	520	1000	2100	4200
Extra fine	270	540	1050	2150
RAW & JPEG (compressed RAW)	130	260	520	1050
RAW (compressed RAW)	170	350	700	1400
RAW & JPEG (uncompressed RAW)	75	150	300	600
RAW (uncompressed RAW)	88	175	355	710

* When [Aspect Ratio] is set to other than [3:2], you can record more images than the numbers shown in the table above (except when [RAW] is selected).

The number of images that can be recorded using a battery pack

Note that the actual numbers may differ depending on the conditions of use.

		Battery life	Number of images
Shooting (still images)	Monitor	—	Approx. 220 images
	Viewfinder	—	Approx. 200 images
Actual shooting (movies)	Monitor	Approx. 30 min.	—
	Viewfinder	Approx. 30 min.	—
Continuous shooting (movies)	Monitor	Approx. 50 min.	—
	Viewfinder	Approx. 50 min.	—
Viewing (still images)		Approx. 170 min.	Approx. 3400 images

Notes

- The above number of images applies when the battery pack is fully charged. The number of images may decrease depending on the conditions of use.
- The number of images that can be recorded is for shooting under the following conditions:
 - The battery pack is used at an ambient temperature of 25°C (77°F).
 - Using Sony Memory Stick PRO Duo (Mark2) media (sold separately)
 - [Viewfinder Bright.] is set to [Manual] [±0].
 - [Monitor Brightness] is set to [Manual] [±0].
 - [Display Quality] is set to [Standard].
- The number for “Shooting (still images)” is based on the CIPA standard, and is for shooting under the following conditions: (CIPA: Camera & Imaging Products Association)
 - DISP is set to [Display All Info.].
 - The focus mode dial is set to S (Single-shot AF).
 - Shooting once every 30 seconds.
 - The power turns on and off once every ten times.
- The number of minutes for movie shooting is based on the CIPA standard, and are for shooting under the following conditions:
 - [Record Setting] is set to [60i 17M(FH)]/[50i 17M(FH)].
 - Typical movie shooting: Battery life based on repeatedly shooting, shooting stand-by, turning on/off, etc.
 - Continuous movie shooting: Battery life based on non-stop shooting until the limit (29 minutes) has been reached, and then continued by pressing the MOVIE button again. Other functions are not operated.

Available recording time for a movie

The table below shows the approximate total recording times using a memory card formatted with this camera. The recording time for XAVC S and AVCHD movies is the recording time when shooting with [Dual Video REC] set to [Off].

Memory card formatted with this camera (h (hour), m (minute))

Capacity Record Setting	8 GB	16 GB	32 GB	64 GB
60p 50M/50p 50M	—	—	—	2 h 35 m
30p 50M/25p 50M	—	—	—	2 h 35 m
24p 50M*/ –	—	—	—	2 h 35 m
120p 50M/100p 50M	—	—	—	2 h 35 m
60i 24M(FX)/ 50i 24M(FX)	40 m	1 h 25 m	3 h	6 h
60i 17M(FH)/ 50i 17M(FH)	55 m	2 h	4 h 5 m	8 h 15 m
60p 28M(PS)/ 50p 28M(PS)	35 m	1 h 15 m	2 h 30 m	5 h 5 m
24p 24M(FX)/ 25p 24M(FX)	40 m	1 h 25 m	3 h	6 h
24p 17M(FH)/ 25p 17M(FH)	55 m	2 h	4 h 5 m	8 h 15 m
1920×1080 60p 28M/ 1920×1080 50p 28M	35 m	1 h 15 m	2 h 35 m	5 h 20 m
1920×1080 30p 16M/ 1920×1080 25p 16M	1 h	2 h	4 h 10 m	8 h 25 m
1280×720 30p 6M/ 1280×720 25p 6M	2 h 35 m	5 h 20 m	10 h 55 m	22 h



* Only when [NTSC/PAL Selector] is set to NTSC
([NTSC/PAL Selector] is only available for models that have AVCHD 50i recording as a default setting.)

- Continuous shooting is possible for approximately 29 minutes. However, the recording time is approximately 5 minutes when shooting movies in XAVC S HD 120p/100p format (a product specification limit). Also, if the file format is set to MP4 (28M), you can shoot continuously for approximately 20 minutes at a time (limited by file size of 4 GB).

Notes

- The recordable time of movies varies because the camera is equipped with VBR (Variable Bit-Rate), which automatically adjusts image quality depending on the shooting scene. When you record a fast-moving subject, the image is clearer but the recordable time is shorter because more memory is required for recording. The recordable time also varies depending on the shooting conditions, the subject or the image quality/size settings.
- The values shown are not for continuous recording time.
- The recording time may differ depending on shooting conditions and the memory card used.
- For details on movie playback, see page 64.

Notes on continuous movie recording

- It requires a lot of power to perform high quality movie recording or continuous shooting using the image sensor. Therefore, if you continue to shoot, the temperature inside the camera will rise, especially that of the image sensor. In such cases, the camera turns off automatically since higher temperatures affect the quality of the images or affect the internal mechanism of the camera.
- The duration of time available for movie recording varies with the temperature or condition of the camera before you start recording. If you frequently recompose or shoot images after the power is turned on, the temperature inside the camera will rise and the recording time available will be shorter.
- When  is indicated, stop recording the movie. The temperature inside the camera has increased to an unacceptable level.
- If the camera stops recording due to the temperature, leave it for several minutes with the power turned off. Start recording after the temperature inside the camera drops fully.
- If you observe the following points, the recording time will be longer.
 - Keep the camera out of direct sunlight.
 - Turn the camera off when it is not being used.
- The maximum continuous recording time is 29 minutes.
- The maximum size of a movie file is about 2 GB, when  File Format] is set to [AVCHD]. When the file size is about 2 GB, a new movie file is created automatically.
- When  File Format] is set to [MP4], a single movie file is limited to approximately 4 GB. Movie recording will stop automatically if the file size of a movie being recorded reaches approximately 4 GB.

Specifications

Camera

[Image sensor]

Image format:

35 mm full size (35.9 mm × 24.0 mm), CMOS image sensor

Effective pixel number of camera:

Approx. 42 400 000 pixels

Total pixel number of camera:

Approx. 43 600 000 pixels

[Lens]

Lens: ZEISS Sonnar T*

35mm single focus lens

Focal length: $f = 35$ mm

While shooting movies:

When [SteadyShot] is set to [Off]: 37 mm

When [SteadyShot] is set to [On]: 44 mm

F value: F2.0

Minimum focus:

When the macro switching ring is set to “0,3m-∞”: 0.3 m (1 ft.)

When the macro switching ring is set to “0,2m-0,35m”: 0.2 m (0.65 ft.)

- Minimum focus is the shortest distance from the image sensor to the subject.

Maximum magnification:

When the macro switching ring is set to “0,3m-∞”: 0.15×

When the macro switching ring is set to “0,2m-0,35m”: 0.26×

Minimum f-stop: F22

Filter diameter: 49 mm

[SteadyShot]

System: Electronic (only for movies)

[Auto focus system]

System: Phase detection system/
Contrast detection system

[Electronic viewfinder]

Type: Electronic viewfinder

Total number of dots: 2 359 296 dots

Frame coverage: 100%

Magnification: Equivalent to approx. 0.74 × with 50 mm lens, at infinity, -1 m^{-1}

Eye Point: Approx. 19 mm from the eyepiece, 18.4 mm from the eyepiece frame at -1 m^{-1} (CIPA standard compliant)

Diopter Adjustment: -4.0 m^{-1} to $+3.0 \text{ m}^{-1}$

[Monitor]

LCD monitor: 7.5 cm (3.0 type) TFT drive

Total number of dots: 1 228 800
(640 × 4 (RGBW) × 480) dots

[Recording format]

File format: JPEG (DCF Ver. 2.0, Exif Ver. 2.3, MPF Baseline) compliant, RAW (Sony ARW 2.3 format)

Movie (XAVC S format): MPEG-4 AVC/H.264 XAVC S ver.1.0 format compliant

Video: MPEG-4 AVC/H.264

Audio: LPCM 2ch (48 kHz 16 bit)

Movie (AVCHD format): AVCHD format Ver. 2.0 compatible
 Video: MPEG-4 AVC/H.264
 Audio: Dolby Digital 2ch, equipped with Dolby Digital Stereo Creator

- Manufactured under license from Dolby Laboratories.

Movie (MP4 format):

Video: MPEG-4 AVC/H.264
 Audio: MPEG-4 AAC-LC 2ch

[Recording media]

Memory Stick media, SD card

- For details, refer to “Memory cards that can be used” (page 55).

[Input/output terminals]

Multi/Micro USB Terminal*:

Hi-Speed USB (USB 2.0)

HDMI: HDMI type D micro jack

 (Microphone) Terminal:

∅ 3.5 mm Stereo mini jack

* Supports Micro USB compatible devices.

[Power, general]

Battery pack: Rechargeable battery pack NP-BX1

[Power consumption (while shooting)]

When using the viewfinder:

Approx. 2.7 W

When using the monitor:

Approx. 2.5 W

[Others]

Exif Print: Compatible

DPOF: Compatible

PRINT Image Matching III:
 Compatible

Dimensions (Approx.): 113.3 mm × 65.4 mm × 72 mm (4 1/2 inches × 2 5/8 inches × 2 7/8 inches)
 (W/H/D, excluding protrusions)

Mass:

Approx. 507 g (1 lb 1.9 oz) (with battery and Memory Stick PRO Duo media)

Approx. 480 g (1 lb 0.9 oz) (body only)

Operating temperature: 0°C to 40°C
 (32°F to 104°F)

[Wireless LAN]

Supported format: IEEE 802.11 b/g/n

Frequency band: 2.4 GHz bandwidth

Security: WEP/WPA-PSK/WPA2-PSK

Connection method: Wi-Fi Protected Setup™ (WPS)/Manual

Access method: Infrastructure mode

NFC: NFC Forum Type 3 Tag compliant

Model No. WW843944

Battery charger BC-DCX

Input rating: DC 5 V

Output rating: 4.2 V DC, 0.86 A

Operating temperature range:

0°C to 40°C (32°F to 104°F)

Storage temperature range:

-20°C to +60°C (-4°F to +140°F)

AC Adaptor

AC-UD10/AC-UUD11/

AC-UUD12/AC-UUE12

Power requirements: AC 100 V to
240 V, 50 Hz/60 Hz, 0.2 A

Output voltage: DC 5 V, 1.5 A

Rechargeable battery pack NP-BX1

Battery type: Lithium-ion battery

Maximum voltage: DC 4.2 V

Nominal voltage: DC 3.6 V

Maximum charge voltage: DC 4.2 V

Maximum charge current: 1.89 A



Capacity: 4.5 Wh (1 240 mAh)

Design and specifications are subject
to change without notice.

On image data compatibility

- This camera conforms with DCF (Design rule for Camera File system) universal standard established by JEITA (Japan Electronics and Information Technology Industries Association).
- Playback of images recorded with your camera on other equipment and playback of images recorded or edited with other equipment on your camera are not guaranteed.

Trademarks

- Memory Stick and  are trademarks or registered trademarks of Sony Corporation.
- XAVC S and  are registered trademarks of Sony Corporation.
- “AVCHD Progressive” and the “AVCHD Progressive” logotype are trademarks of Panasonic Corporation and Sony Corporation.
- Dolby and the double-D symbol are trademarks of Dolby Laboratories.
- The terms HDMI and HDMI High-Definition Multimedia Interface, and the HDMI Logo are trademarks or registered trademarks of HDMI Licensing LLC in the United States and other countries.
- Windows is a registered trademark of Microsoft Corporation in the United States and/or other countries.
- Mac is a registered trademark of Apple Inc. in the United States and other countries.
- iOS is a registered trademark or trademark of Cisco Systems, Inc.
- iPhone and iPad are registered trademarks of Apple Inc. in the United States and other countries.
- SDXC logo is a trademark of SD-3C, LLC.
- Android and Google Play are trademarks of Google Inc.
- Wi-Fi, the Wi-Fi logo and Wi-Fi Protected Setup are registered trademarks or trademarks of the Wi-Fi Alliance.

- The N Mark is a trademark or registered trademark of NFC Forum, Inc. in the United States and in other countries.
- DLNA and DLNA CERTIFIED are trademarks of Digital Living Network Alliance.
- Facebook and the “f” logo are trademarks or registered trademarks of Facebook, Inc.
- YouTube and the YouTube logo are trademarks or registered trademarks of Google Inc.
- Eye-Fi is a trademark of Eye-Fi, Inc.
- In addition, system and product names used in this manual are, in general, trademarks or registered trademarks of their respective developers or manufacturers. However, the TM or ® marks may not be used in all cases in this manual.

LITHIUM ION  TYPE

 MEMORY STICK  CLASS I

Index

A

- Area Setting 58
- AUTO 61
- Auto Mode 61

B

- Battery pack 47

C

- Camera shake 59
- Charge lamp 49
- Charging battery pack 47
- Computer 77, 78, 80
- Control wheel 32
- Creative Style 71
- Custom Key(PB) 41
- Custom Key(Shoot.) 41

D

- Date/Time Setup 57
- Delete 66
- Diopter-adjustment 22
- DISP 25, 40
- Drive Mode 36
- DRO/Auto HDR 71

E

- Exposure compensation dial 29
- Eye sensor 18
- Eye-piece cup 23

F

- Fn 33, 34
- Focus Area 70
- Focus Magnif. Time 39
- Focus Mode 70
- Function button 33, 34

H

- Help Guide 2

I

- Image Data Converter 77
- Image Size 69
- In-Camera Guide 46
- ISO 37

L

- Language 44, 57
- LPF Effect 72

M

Macro switching ring.....	62
Memory card	54, 55
Memory recall	67
MENU	35
Microphone jack.....	20
Monitor	25
MOVIE	63
MOVIE Button	63
Multi interface shoe	20

N

NFC	73
Number of recordable images.....	81

P

PlayMemories Camera Apps	75
PlayMemories Home	78, 79

Q

Quick Navi.....	30
-----------------	----

R

Recordable time of movies	83
Remote Camera Control	80

S

Scene Selection	38
Set the clock.....	58
Shooting mode	67
Shooting still images.....	61
Shoulder strap	19
Software.....	77, 78, 80
Specifications.....	85
SteadyShot	60

V

View Mode	65
Viewfinder	22
Viewing image.....	64

W

White Balance.....	37
Wi-Fi.....	9, 73

Z

Zebra	39
-------------	----



<http://www.sony.net/SonyInfo/Support/>

Additional information on this product and answers to frequently asked questions can be found at our Customer Support Website.

<http://www.sony.net/>

